

Cavaletti

CADEIRAS PROFISSIONAIS



Cavaletti Vélo

Cavaletti Vélo

Dinamismo, agilidade e velocidade são indispensáveis no ambiente corporativo contemporâneo. Para ele, a Cavaletti criou a Linha Vélo, um produto inspirado nos conceitos de flexibilidade e leveza para oferecer ergonomia e conforto dinâmico para todos os tipos de uso. Um projeto global, com design original, Made in Brazil.



Parceiro da Cavaletti desde 2011, Marc Sapetti nasceu em Andorra e formou-se em design industrial em Barcelona. Nos anos seguintes trabalhou em escritórios relevantes na Europa, culminando recentemente com a criação do seu próprio escritório. Hoje, a Sapetti Design Consultancy é um estúdio multipremiado, entre eles IF Awards (Cavaletti Go) e Good Design Award (Cavaletti Idea). Para Marc, "Design não é só um produto, mas a soma de diferentes fatores como engenharia, comunicação, design e ergonomia".



CARACTERÍSTICAS



APOIO DE CABEÇA

Com dimensões generosas, oferece maior suporte a região cervical. Área de contato com revestimento em espuma PU Soft Touch.



ESPALDAR

Encosto alto em todas as versões. Apoio lombar ajustável (modelos operativos). Disponível nas cores Cinza Claro e Carbon. Opção de capa acolchoada em Poliéster, Mescla, Politex, CEC - Stilo ou Couro Natural.



MECANISMOS

Mecanismo Sincron de 4 estágios com regulagem de tensão por manipulo frontal ou Mecanismo SRE MC, ambos com regulagem de profundidade do assento. Opção de plataforma giratória para Salas de Reunião (SR).

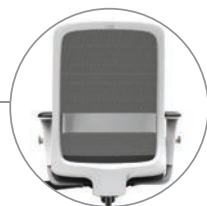

TELA

Membrana inteligente de alta resistência, que se adapta a curvatura da coluna proporcionando suporte e ventilação constantes. Disponível em oito cores exclusivas.



ASSENTO

Assento em espuma injetada, com regulagem de Profundidade (modelos operativos). Regulagem de Altura à Gás. Revestimentos disponíveis em Poliéster, Politex, Mescla, Grid, Haven, Space, CEC - Stilo, Vinil e Couro Natural.



BRAÇOS

Braços ID (regulável em altura e afastamento lateral, com opção de revestimento do apoio braço em couro) e 3D (regulável em altura, avanço e ângulo do apoio PU).



BASES

Opções de Bases em Alumínio ou Nylon, com rodízios de 65mm em Nylon ou PU.



ESTRUTURAS

Estruturas fixas com rodízios ou sapatas, com ou sem Braços Integrados (SI). Pintura nas cores Prata ou Preto Universal.

CONFIGURAÇÕES



42.101 AC
Giratória Operativa
Sincron RP
Braços ID
Base Alumínio
Apoio Lombar
Apoio de Cabeça
Capa Acolchoada



42.101 AC
Giratória Operativa
Sincron RP
Braços ID
Base Nylon
Apoio Lombar
Apoio de Cabeça



42.101
Giratória Operativa
Sincron RP
Braços ID
Apoio Lombar
Base Nylon



42.101 SR
Giratória Reunião
Plataforma Giratória
Base Nylon



42.106 ROD
Aproximação Giratória
Estrutura P
Braços Integrados



42.106 SI
Aproximação
Estrutura SI
Braços Integrados

TELAS

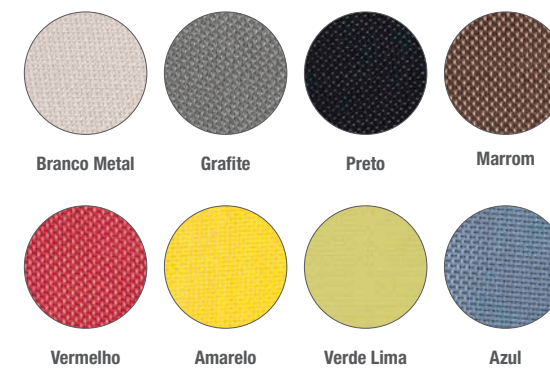

SUPERFÍCIES PLÁSTICAS

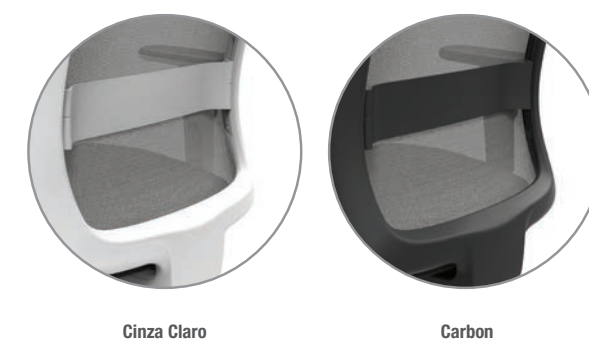

DESENHOS TÉCNICOS

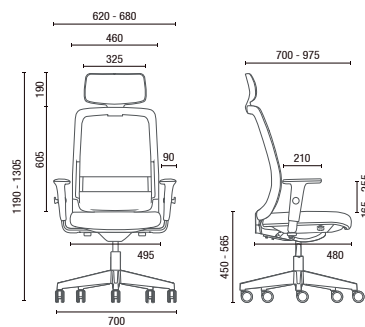

42.101 AC **Giratória Operativa**

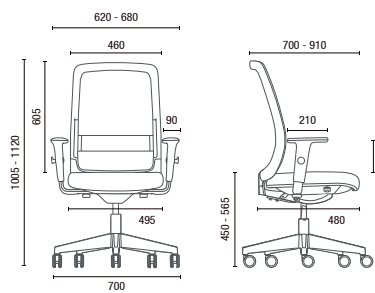

42.101 **Giratória Operativa**

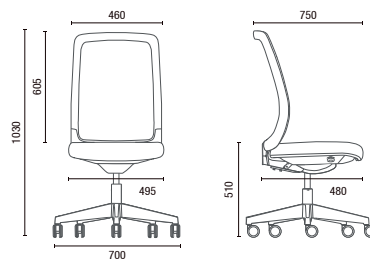

42.101 SR **Giratória Reunião**

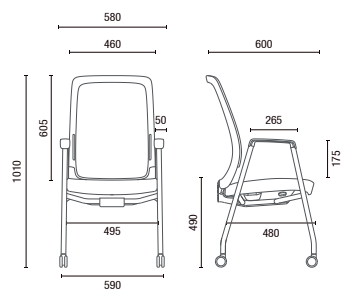

42.106 ROD **Aproximação Giratória**

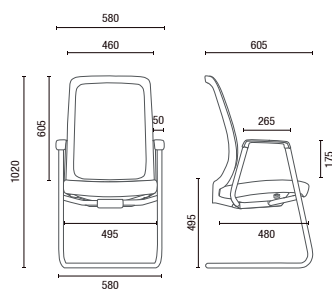

42.106 SI **Aproximação**

OBS: Medidas extremas obtidas sem o uso de gabarito de carga.



Cavaletti S/A Cadeiras Profissionais
Rua Dr. Hiram Sampaio, 550
Erechim/RS Brasil 99.706-461
Fone/Fax: (54) 3520.4100
atendimento@cavaletti.com.br
www.cavaletti.com.br



*Produtos Certificados com Rótulo Ecológico (Qualidade - ABNT - Ambiental) ou Norma ABNT NBR 13962, sob consulta ao Departamento Comercial - Setor Público.

Cavaletti

CADEIRAS PROFISSIONAIS

®



Cavaletti Idea



Cavaletti Idea

Novas ideias para novos tempos. A Cavaletti Idea busca tornar acessível o design e a alta qualidade ergonômica para todos os tipos de escritório. Um produto feito no Brasil, com alto padrão de qualidade e inspirado nos conceitos contemporâneos de trabalho colaborativo.

CARACTERÍSTICAS

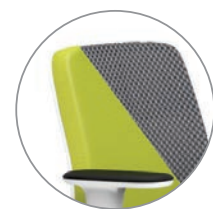

REVESTIMENTOS

Espaldar com estrutura interna flexível e duas opções de acabamento: Soft (nas opções Haven, Poliéster, Polítex, Mescla, Grid, Space, CEC - Stilo, Vinil e Couro Natural) ou Mesh (na opção Space).



CORES

Três opções de cores para as superfícies plásticas principais: Branco Off, Cinza Claro ou Carbon.



ESPAJDAR

Espaldar regulável em altura, com acionamento por gatilho.



BASES

Opções de Bases em Alumínio ou Nylon, com rodízios de 65mm em Nylon ou PU.



MECANISMOS

Mecanismo Synchron de 4 estágios com regulagem de tensão por manípulo frontal ou Mecanismo SRE MC, ambos com regulagem de profundidade do assento. Opção de plataforma giratória para Salas de Reunião (SR).



BRAÇOS

Braços ID (regulável em altura e afastamento lateral, com opção de revestimento do apoio braço em couro), 3D (regulável em altura, avanço e ângulo do apoio PU) e 4D CA (regulável em altura, distanciamento lateral, avanço e ângulo do apoio PU).



ASSENTO

Assento em espuma injetada, Regulagem de Profundidade e Regulagem de Altura à Gás. Revestimentos disponíveis em Poliéster, Polítex, Mescla, Grid, Space, Haven, CEC - Stilo, Vinil e Couro Natural.



ESTRUTURAS

Estrutura fixa Balanço com Braços Integrados (SI) e Pintura em Prata ou Preto Universal.

CONFIGURAÇÕES

IDEA SOFT



40.101
Giratória Alta
Synchron RP
Braços ID
Base Alumínio



40.102
Giratória Média
Synchron RP
Braços ID
Base Alumínio



40.106 SI
Aproximação
Estrutura SI
Braços Integrados

IDEA MESH



40.202
Giratória Média
Synchron RP
Braços ID
Base Nylon



40.202 SR
Giratória Média
Plataforma Giratória
Base Nylon



40.206 SI
Aproximação
Estrutura SI
Braços Integrados

CORES

Três opções de tonalidade para superfícies plásticas.



Branco Off



Cinza Claro



Carbon

DESENHOS TÉCNICOS

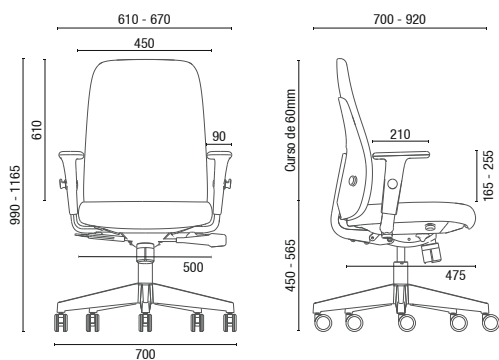

40.101 Giratória Alta

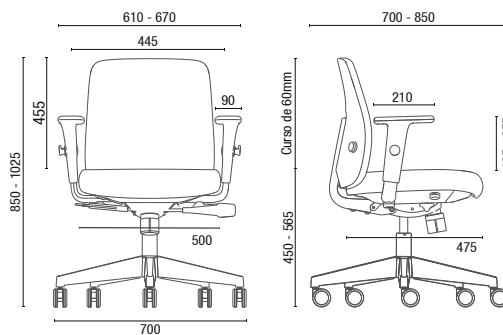

40.102 / 40.202 Giratória Média

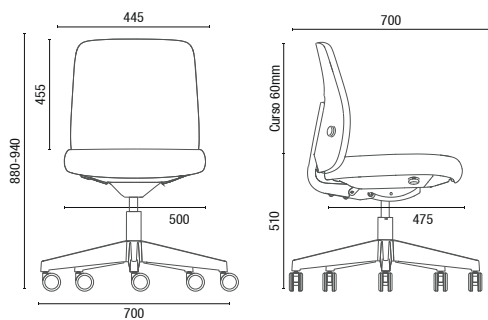

40.202 SR Giratória Média

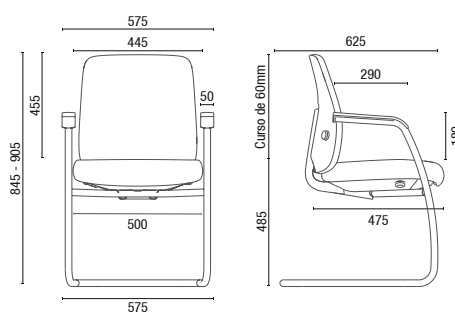

40.106 SI / 40.206 SI Aproximação

OBS: Medidas extremas obtidas sem o uso de gabarito de carga.



Cavaletti S/A Cadeiras Profissionais
Rua Dr. Hiram Sampaio, 550
Erechim/RS Brasil 99.706-461
Fone/Fax: (54) 3520.4100
atendimento@cavaletti.com.br
www.cavaletti.com.br



*Produtos Certificados com Rótulo Ecológico (Qualidade - ABNT - Ambiental) ou Norma ABNT NBR 13962, sob consulta ao Departamento Comercial - Setor Público.

®

Cavaletti

CADEIRAS PROFISSIONAIS



Cavaletti Moov



Cavaletti Moov

A Cavaletti Moov é uma cadeira *multitask*, ideal para ambientes dinâmicos. Do escritório corporativo ao *coworking*, há sempre uma versão para atender às necessidades do projeto.

CARACTERÍSTICAS



ENCOSTOS

Três opções de encosto: tela, polímero de engenharia e polímero de engenharia com sobrecapa.



ENCOSTO REVESTIDO

Sobrecaça do encosto com duas opções de costura: lisa e diamante.



ESTRUTURA

Estrutura em polímero de engenharia disponível em Cinza e Preto conforme configuração.



BRAÇOS

Fixo: braço TC.
Reguláveis: braço SL e MC. Todos os modelos estão disponíveis nas cores Preto e Cinza.



BASES

Bases Up (com Rodízios 65mm em Nylon ou PU) e Aço com Capa (com Rodízios 50mm em Nylon ou PU), disponíveis em Preto e Cinza.



MECANISMO

Mecanismo do tipo Synchron, com travamento da posição inicial ou relax livre e regulagem automática da tensão, ajustando-se ao peso do usuário sem a necessidade de ajuste manual.

DESIGN EM MOVIMENTO

A Moov é uma cadeira versátil que apresenta três opções de encosto: tela, polímero de engenharia e polímero de engenharia com sobrecaça estofada. Essa diversidade permite a adequação do modelo à necessidade de cada atividade.



OBS.: Produto nesta imagem com Politex Cinza Escuro 404.

OBS.: Produtos nesta imagem com tela Azul 303 e Politex Cinza Metal 402; Haven Concreto 562 e Haven Areia 560; Haven Campo 556; Poliéster Amarelo 258; tela Branco Metal 307 e Poliéster Tangerina 172; Haven Terracota 552; tela Grafite 308; Haven Terra 561.

CUSTOMIZE À VONTADE

Leve e com flexibilidade de configurações facilita a especificação tanto para ambientes de uso rápido quanto para ambientes operacionais de uso intenso. As duas opções de cores de estrutura, as seis opções de revestimento e as oito opções de cores de tela permitem à Cavaletti Moov ser complementar ao *moodboard* do projeto, desde o mais formal até o mais despojado.



OBS.: Produtos nesta imagem com Haven Campo 556; Terracota 552; Terra 561; Areia 560 e Haven Campo 556.

REVESTIMENTOS

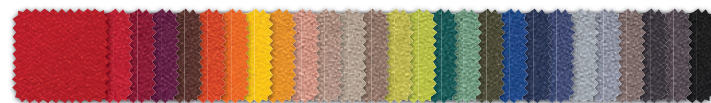

POLIÉSTER
27 cores

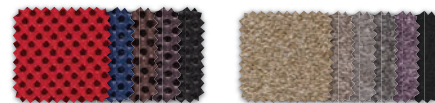

SPACE
05 cores

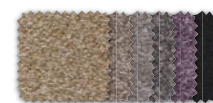

POLITEX
06 cores

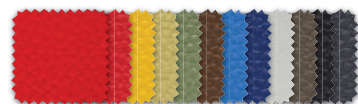

VINIL
12 cores



CEC - STILO
10 cores

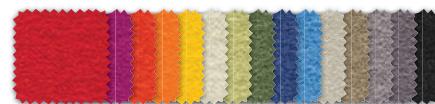

HAVEN
15 cores

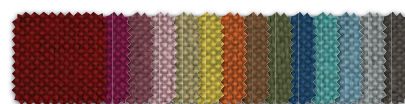

GRID
14 cores

CONFIGURAÇÕES

Confira abaixo algumas combinações possíveis para a Cavaletti Moov e escolha a sua.



17.101
Giratória
Sincron
Encosto em tela
Estrutura preta
Braço MC
Base Up



17.201
Giratória
Sincron
Encosto em polímero de engenharia
Estrutura preta
Braço MC
Base Up



17.301
Giratória
Sincron
Encosto em polímero de engenharia com sobrecapa
Estrutura preta
Braço MC
Base Up



17.101
Giratória
Sincron
Encosto em tela
Estrutura cinza
Braço MC
Base Up



17.201
Giratória
Sincron
Encosto em polímero de engenharia
Estrutura cinza
Braço MC
Base Up



17.301
Giratória
Sincron
Encosto em polímero de engenharia com sobrecapa
Estrutura cinza
Braço MC
Base Up

OBS.: Produtos nesta imagem com tela Grafite 308 e Polítex Cinza Metal 402.

ESTRUTURAS



Preto



Cinza

COSTURA



Diamante



Lisa

TELAS



Branco Metal

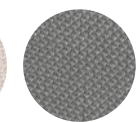

Grafite



Preto

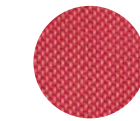

Vermelho



Amarelo



Verde Lima



Marrom

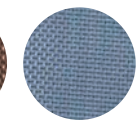

Azul

DESENHOS TÉCNICOS

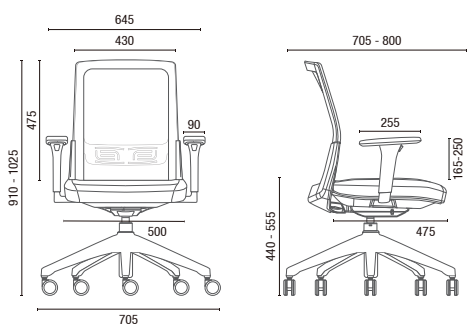

17.101 Giratória - Braço MC e Base Up

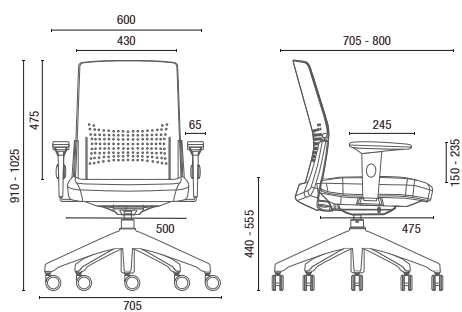

17.201 Giratória - Braço SL e Base Up

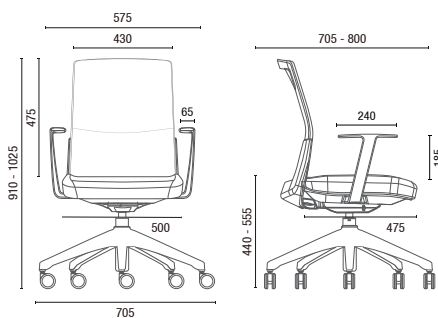

17.301 Giratória - Braço TC e Base Up

OBS.: Produtos da capa com tela Branco Metal 307 e Haven Céu 559; Haven Terracota 552; Haven Areia 560.

OBS.: Medidas extremas obtidas sem o uso de gabarito de carga.



Cavaletti S/A Cadeiras Profissionais
Rua Dr. Hiram Sampaio, 550
Erechim/RS Brasil 99.706-461
Fone/Fax: (54) 3520.4100
atendimento@cavaletti.com.br
www.cavaletti.com.br



A marca do manejo florestal responsável



Cavaletti

CADEIRAS PROFISSIONAIS



Cavaletti Flip



Cavaletti Flip

Dinamismo e agilidade são qualidades comuns aos ambientes corporativos contemporâneos. A Cavaletti desenvolveu a linha Flip para atender às exigências de versatilidade e qualidade ergonômica nos mais variados tipos de uso.

CARACTERÍSTICAS



MECANISMOS
Sistema de Reclinação do Encosto (SRE) ou Encosto Sem Regulagem (BG).



BRAÇOS
Braços Reguláveis SL, SL New PU, SL New PP (todos com opção de Regulagem Lateral) ou 3D (regulável em altura, avanço e ângulo do apoio PU). Opção de braço fixo, modelo TC.



ASSENTO
Assento em espuma injetada, com regulagem de altura à gás.



BASES
Opções de Bases em Alumínio ou Nylon, com rodízios de 65mm em Nylon ou PU. Base em Aço com Capa, somente rodízios de 50mm em Nylon ou PU.



ESPALDAR
Estrutura em plástico injetado de alta resistência com regulagem de altura. Disponível na cor Preto e Cinza.



TELA
Membrana que se adapta à curvatura da coluna, proporcionando suporte e ventilação constantes. Disponível nas cores Preto e Cinza.

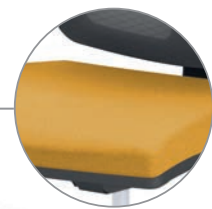

REVESTIMENTOS
Revestimentos disponíveis em Poliéster, Polítex, Mescla, Grid, Space, Haven, CEC - Stilo, Vinil e Couro Natural.



ESTRUTURAS
Estrutura Z com Braços Integrados, com sapatas ou rodízios. Estrutura S com Braços fixos, sem Braços ou com Braços Integrados. Acabamento Cromado ou Pintura em Preto Universal.

CONFIGURAÇÕES



43.103 SRE
Executiva Giratória
Sistema Reclinador de Encosto (SRE)
Braços TC
Base Nylon
Rodízios 65mm



43.106 S
Executiva Aproximação
Estrutura S
Braços Loop



43.106 SI
Executiva Aproximação
Estrutura SI
Braços Integrados



43.106 Z
Executiva Aproximação
Estrutura Z
Braços Integrados



43.106 Z ROD
Executiva Aproximação
Estrutura Z com rodízios 50mm
Braços Integrados



43.122
Stool
Encosto Fixo
Braços TC
Base Nylon com sapatas (Polaina Opcional)
*Sistema Reclinador de Encosto (SRE) Opcional



43.110
Executiva Longarina
Braços Loop Intercalado
Estrutura Pé Preto ou Cromado
Sapata traseira com Regulagem
*Não disponível com os Braços TC

TELAS

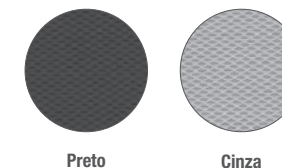

DESENHOS TÉCNICOS

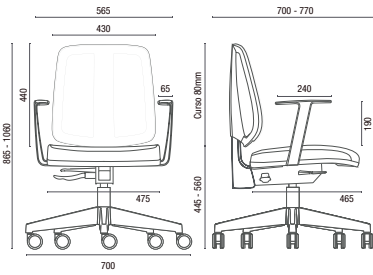

43.103 SRE Executiva Giratória

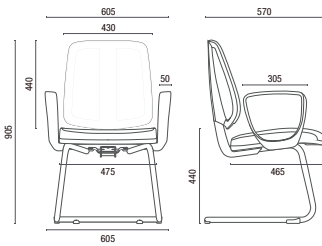

43.106 S Executiva Aproximação

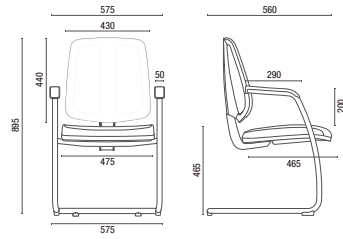

43.106 SI Executiva Aproximação

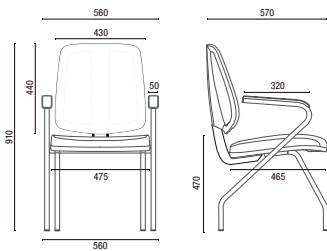

43.106 Z Executiva Aproximação

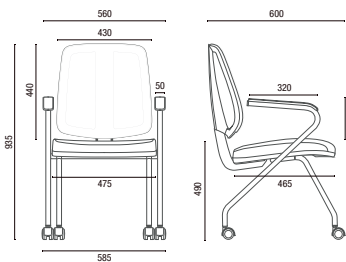

43.106 Z ROD Executiva Aproximação

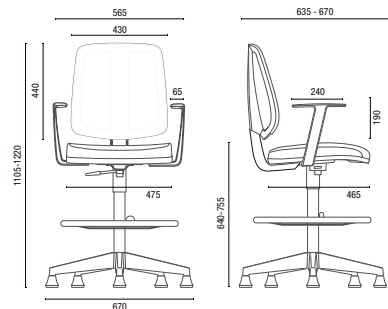

43.122 Stool

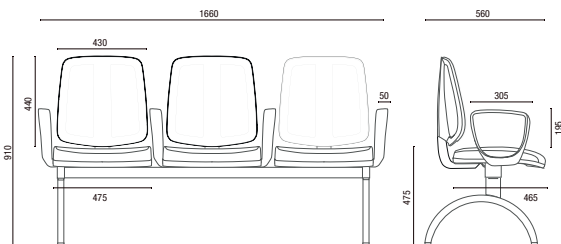

43.110 Executiva Longarina

Larguras Braços Loop Intercalado:

- 2L - 1110mm
- 3L - 1660mm
- 4L - 2195mm
- 5L - 2735mm

OBS: Medidas extremas obtidas sem o uso de gabarito de carga.



Cavaletti S/A Cadeiras Profissionais
Rua Dr. Hiram Sampaio, 550
Erechim/RS Brasil 99.706-461
Fone/Fax: (54) 3520.4100
atendimento@cavaletti.com.br
www.cavaletti.com.br



Procure por nossos produtos certificados FSC®



A marca do manejo florestal responsável



*Produtos Certificados com Rótulo Ecológico (Qualidade - ABNT - Ambiental) ou Norma ABNT NBR 13962, sob consulta ao Departamento Comercial - Setor Público.

Cavaletti®

CADEIRAS PROFISSIONAIS



Cavaletti Air

Cavaletti Air

Os produtos da linha Air se adaptam às formas e necessidades do ser humano. Com ajustes projetados para oferecer excelente ergonomia e conforto para uso intenso, a Air oferece opções de regulagens individuais como altura do apoio lombar e profundidade do assento, que ampliam sensivelmente o suporte e as áreas de sustentação corporal, adaptando-se de acordo com a constituição física de cada usuário.



CARACTERÍSTICAS

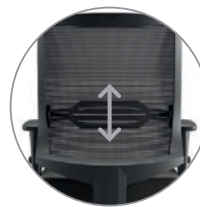

APOIO LOMBAR

Apoio Lombar Regulável integrado ao encosto, permite ajuste vertical de 50 mm de curso. Melhor suporte da coluna vertebral.

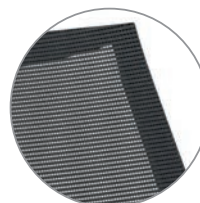

ESPALDAR

Estrutura em plástico injetado de alta resistência e apoio em tela tipo *mesh*, disponível nas cores Preto e Cinza.



MECANISMO

Mecanismo Synchron de 4 estágios com regulagem de tensão por manípulo frontal ou Mecanismo SRE MC (ambos com opção de regulagem de profundidade do assento). Opção de plataforma giratória para Salas de Reunião (SR).



BASES

Opções de Bases em Alumínio ou Nylon, com rodízios de 65mm em Nylon ou PU. Base em Aço com Capa, somente rodízios de 50mm em Nylon ou PU.



REVESTIMENTOS

Revestimentos disponíveis para o assento em Poliéster, Politex, Mescla, Grid, Space, Haven, CEC - Stilo, Vinil e Couro Natural.



BRAÇOS

Braços Reguláveis SL, SL New PU, SL New PP (todos com opção de Regulagem Lateral) ou 3D (regulável em altura, avanço e ângulo do apoio PU). Braços Integrados nos modelos fixos.



ASSENTO

Em espuma de alta performance com Regulagem de Altura à Gás e opção de Regulagem de Profundidade.

CONFIGURAÇÕES



27001
Poltrona Giratória
Synchron RP
Apoio Lombar Regulável
Braço 3D
Base Alumínio



27001
Poltrona Giratória
Synchron RP
Apoio Lombar Regulável
Braço 3D
Base Nylon



27006 SI
Poltrona Aproximação
Estrutura SI
Braços Integrados
Tela cor Preto



27006 SI
Poltrona Aproximação
Estrutura SI
Braços Integrados
Tela cor Cinza

CORES TELA

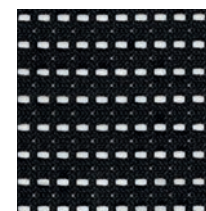

Preto



Cinza

DESENHOS TÉCNICOS

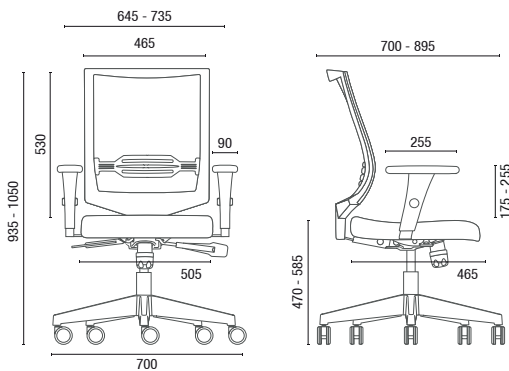

27001 Poltrona Giratória

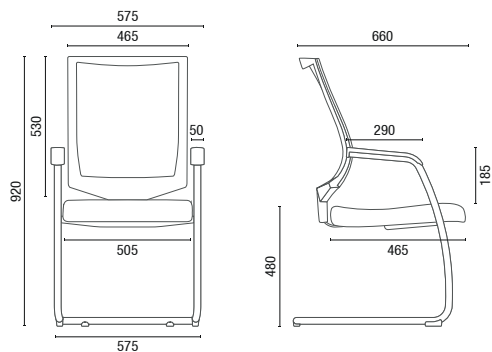

27006 SI Poltrona Aproximação

OBS: Medidas extremas obtidas sem o uso de gabarito de carga.



Cavaletti S/A Cadeiras Profissionais
Rua Dr. Hiram Sampaio, 550
Erechim/RS Brasil 99.706-461
Fone/Fax: (54) 3520.4100
atendimento@cavaletti.com.br
www.cavaletti.com.br



Procure por nossos produtos certificados FSC®



A marca do manejo florestal responsável



Cavaletti®

CADEIRAS PROFISSIONAIS



Cavaletti NewNet
Cavaletti NewNet Soft

Cavaletti NewNet

A linha NewNet oferece a experiência única proporcionada pelo encosto em tela. Desenvolvido para adaptar-se continuamente à curvatura da coluna e oferecer maior apoio, este material também proporciona melhor ventilação natural quando em uso. A NewNet Soft é resultado da união da tela de dupla membrana com a flexibilidade das cores e materiais de revestimento, unindo a ergonomia proporcionada pela tela à variedade de acabamentos de uma cadeira estofada, em design sofisticado e único.



CARACTERÍSTICAS



ACESSÓRIOS
Opção de Apoio para a Cabeça disponível para os modelos 16001 e 16501.



MECANISMOS
Mecanismo Synchron de 4 estágios com regulagem de tensão por manípulo frontal ou Mecanismo SRE MC (ambos com opção de regulagem de profundidade do assento) e em alguns modelos da linha, o Sistema de Reclinação do Encosto (SRE).



REVESTIMENTOS
Diferentes opções de revestimentos para assento NewNet ou assento e encosto NewNet Soft: Poliéster, Space, CEC - Stilo, Vinil, Mescla, Politex, Haven, Couro Natural e Grid.

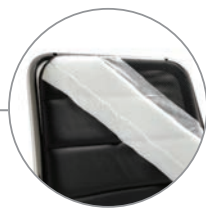

ENCOSTO
Tela de dupla membrana (modelos 16000) com opção de revestimento para NewNet Soft (modelos 16500).



ASSENTO
Assento em espuma injetada com Regulagem de Altura à Gás.



BRAÇOS REGULÁVEIS
Modelos giratórios com Braços Reguláveis SL, SL New PU, SL New PP (todos com opção de Regulagem Lateral) ou 3D (regulável em altura, avanço e ângulo do apoio PU).



BASES
Opções de Bases em Alumínio ou Nylon, com rodízios de 65mm em Nylon ou PU. Base Estampada ou Aço com Capa, somente rodízios de 50mm em Nylon ou PU.



ESTRUTURA
Estruturas fixas com Braços Integrados. Acabamento Cromado ou Preto Universal.



CONFIGURAÇÕES

NEWNET



16001 AC
Presidente Giratória
Synchron
Braço 3D
Base Alumínio



16001
Presidente Giratória
Synchron
Braço 3D
Base Estampada



16002
Diretor Giratória
Synchron
Braço 3D
Base Nylon



16003 SRE
Executiva Giratória
Sistema Reclinador do Encosto
Braço SL
Base Nylon



16006 S
Executiva Aproximação
Estrutura S
Braços Integrados



16010
Longarina Executiva
L2048 Fixo
Braço Loop Intercalado
Sapata traseira com regulagem



16010
Longarina Executiva
L2048 Fixo
Sapata traseira com regulagem

OBS: Produto nesta imagem com revestimento em Poliéster Grafite (257)

NEWNET SOFT



16501 AC
Presidente Giratória
Synchron
Braço 3D
Base Alumínio



16501
Presidente Giratória
Synchron
Braço 3D
Base Estampada



16503 SRE
Executiva Giratória
Sistema Reclinador de Encosto
Braço SL New PU
Base Estampada



16506 S
Executiva Aproximação
Estrutura S
Braços Integrados

OBS: Produto nesta imagem com revestimento em CEC - Stilo Bege (080)

OBS: Produto nestas imagens e na capa deste catálogo com revestimento em Couro Natural Caramelo e em detalhe Preto.

DESENHOS TÉCNICOS

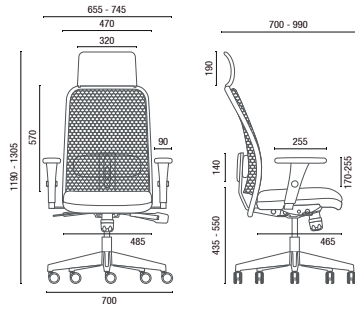

16001 AC Presidente Giratória

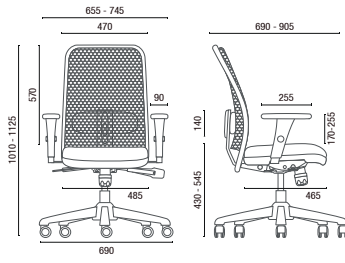

16001 Presidente Giratória

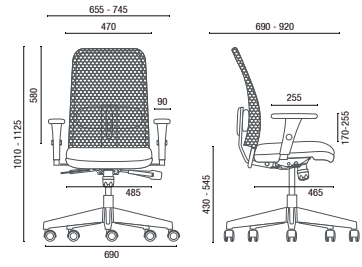

16002 Diretor Giratória

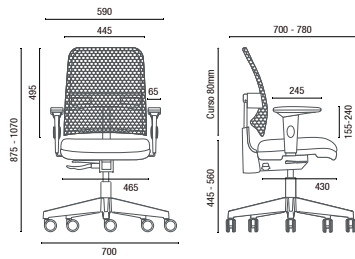

16003 SRE Executiva Giratória

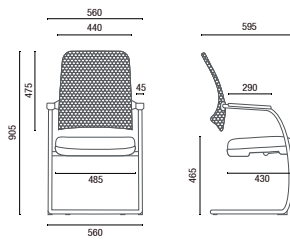

16006 S Executiva Aproximação

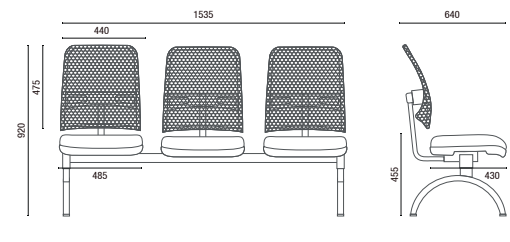

16010 Longarina Executiva

Larguras sem Braço: Larguras com Braço Intercalado Loop:
 2L - 1010mm 2L - 1145mm
 3L - 1535mm 3L - 1675mm
 4L - 2070mm 4L - 2190mm
 5L - 2600mm 5L - 2730mm

NEUNET SOFT

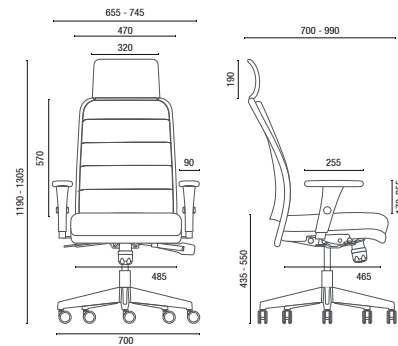

16501 AC Presidente Giratória

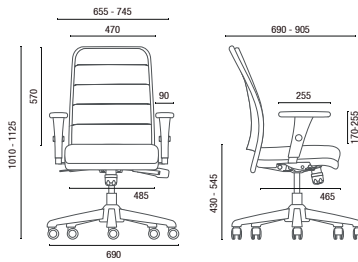

16501 Presidente Giratória

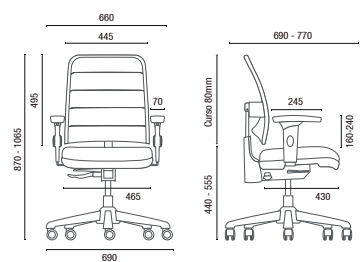

16503 SRE Executiva Giratória

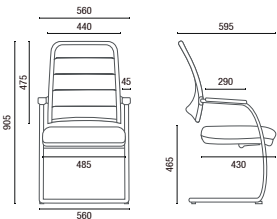

16506 S Executiva Aproximação

OBS: Medidas extremas obtidas sem o uso de gabarito de carga.



A marca do manejo florestal responsável



*Produtos Certificados com Rótulo Ecológico (Qualidade - ABNT - Ambiental) ou Norma ABNT NBR 13962, sob consulta ao Departamento Comercial - Setor Público.

®

Cavaletti

CADEIRAS PROFISSIONAIS



Cavaletti PRO



Cavaletti Pro

Espaços de trabalho dinâmicos pedem assentos confortáveis, práticos e duráveis, que se integrem à arquitetura de cada ambiente. Criada para atender áreas operativas e gerenciais, a linha Pro oferece soluções para atender de forma inteligente uma grande variedade de usuários, com alto índice de conforto e funcionalidade.

CARACTERÍSTICAS

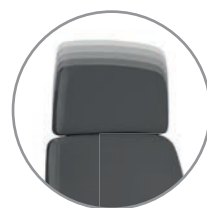

APOIO DE CABEÇA

Apoio de cabeça com 5 posições de ajuste e 35 mm de curso. Com dimensões generosas, oferece maior sustentação à região cervical.



ESPALDAR

Espaldares Alto (L AC), Alto (L), Alto (Operacional) e Médio (Operacional), com curvaturas anatômicas para maior suporte da coluna vertebral.

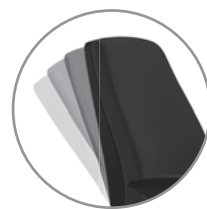

MECANISMOS

Mecanismo Synchron de 4 estágios com regulagem de tensão por manípulo frontal (com opção de regulagem de profundidade do assento), Mecanismo Relax ou Sistema de Reclinação do Encosto (SRE). Opção de plataforma giratória para Salas de Reunião (SR).



BASES

Opções de Bases em Alumínio ou Nylon, com rodízios de 65mm em Nylon ou PU. Base em Aço com Capa, somente rodízios de 50mm em Nylon ou PU.

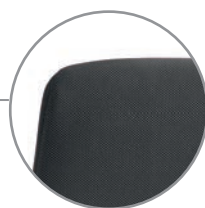

REVESTIMENTOS

Tecidos selecionados com costuras duplas nas opções: Poliéster, Polítex, Mescla, Grid, Haven, Space, CEC - Stilo, Vinil e Couro Natural.



BRAÇOS

Braços Reguláveis SL, SL New PU, SL New PP (todos com opção de Regulagem Lateral) ou 3D (regulável em altura, avanço e ângulo do apoio PU).



ASSENTO

Assento em espuma injetada com regulagem de altura à gás. Opcional regulagem de Profundidade quando houver mecanismo Synchron.



ESTRUTURAS

Bases fixas na opção Balanço com ou sem Braços Integrados (S ou SI) e Sapata Estabilizadora. Acabamento Cromado ou Preto Universal.

38001 L AC
Presidente Giratória
Synchron
Braço SL
Base Alumínio

CONFIGURAÇÕES



38001 L AC
Presidente Giratória
Synchron
Braço SL
Base Aço com Capa



38001 L
Presidente Giratória
Synchron
Braço SL New PU
Base Aço com Capa



38001 SRE
Operacional Alta
Sistema Reclinador do Encosto
Braço SL
Base Aço com Capa



38003 SRE
Operacional Média
Sistema Reclinador do Encosto
Braço SL
Base Aço com Capa



38022 SRE
Stool Média
Sistema Reclinador do Encosto
Braço SL
Base Aço com Capa



38006 SI
Aproximação Alta
Estrutura SI
Braços Integrados



38006 S
Aproximação Alta
Estrutura S



38007 SI
Aproximação Média
Estrutura SI
Braços Integrados



38007 S
Aproximação Média
Estrutura S



38010
Longarina Média
Sapata traseira com regulagem



38010
Longarina Média
Braços Intercalado Americano
Sapata traseira com regulagem

DESENHOS TÉCNICOS

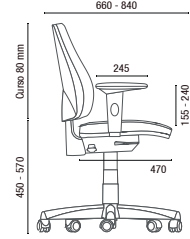
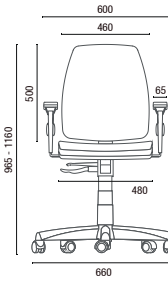
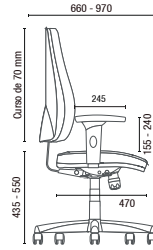
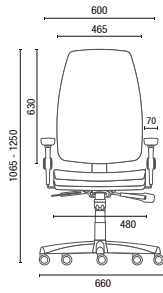
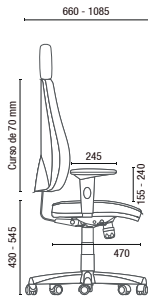
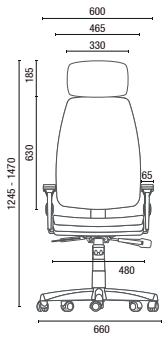

38001 L AC SYNCRON **Presidente Giratória**

38001 L SYNCRON **Presidente Giratória**

38001 SRE **Operacional Alta**

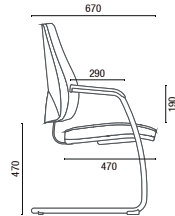
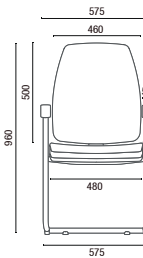
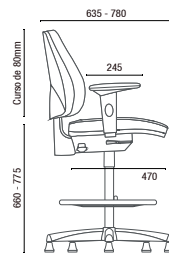
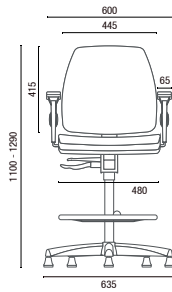
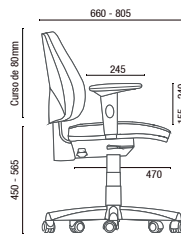
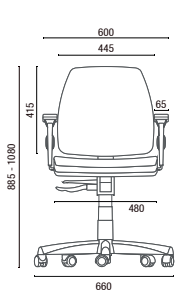

38003 SRE **Operacional Média**

38022 SRE **Stool Média**

38006 SI **Aproximação Alta com Braços Integrados**

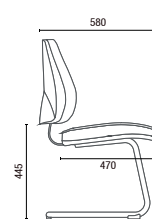
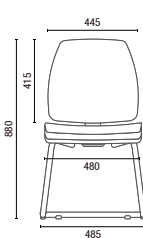
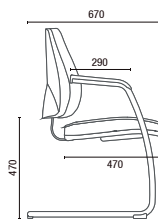
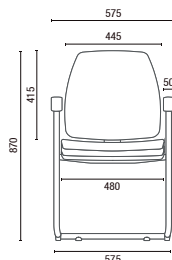
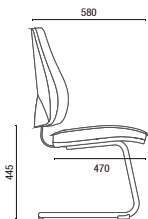
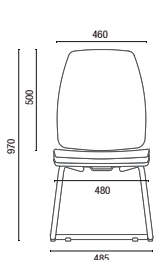

38006 S **Aproximação Alta**

38007 SI **Aproximação Média com Braços Integrados**

38007 S **Aproximação Média**

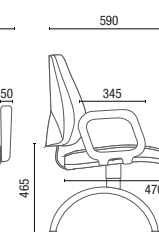
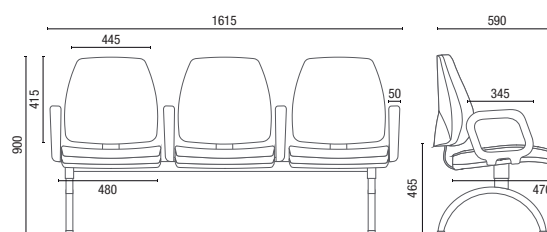
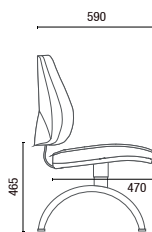
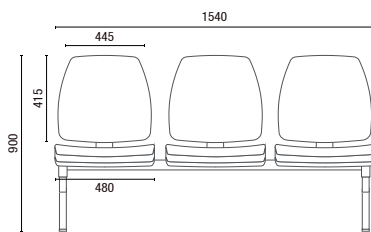

38010 **Longarina Média**

Larguras sem Braço:
2L - 1015mm
3L - 1540mm
4L - 2055mm
5L - 2600mm

38010 **Longarina Média**

Larguras com Braço Intercalado Americano:
2L - 1085mm
3L - 1615mm
4L - 2130mm
5L - 2670mm

OBS: Medidas extremas obtidas sem o uso de gabarito de carga.



Cavaletti S/A Cadeiras Profissionais
Rua Dr. Hiram Sampaio, 550
Erechim/RS Brasil 99.706-461
Fone/Fax: (54) 3520.4100
atendimento@cavaletti.com.br
www.cavaletti.com.br



A marca do manejo florestal responsável



*Produtos Certificados com Rótulo Ecológico (Qualidade - ABNT - Ambiental) ou Norma ABNT NBR 13962, sob consulta ao Departamento Comercial - Setor Público.

Cavaletti

CADEIRAS PROFISSIONAIS



Cavaletti Mais

Cavaletti Mais

A linha Mais oferece design centrado no essencial, adaptando-se a diversos estilos de ambientes. Desenvolvida utilizando conceitos ergonômicos e engenharia de ponta, a Mais dispõe de produtos funcionais e de uso prático, facilitando a busca pela postura de trabalho ideal de forma simples sem complicações.



CARACTERÍSTICAS



REVESTIMENTOS

Revestimentos disponíveis nos tecidos Haven, Poliéster, Politex, Mescla, Grid, Space, CEC - Stilo, Vinil e Couro Natural.

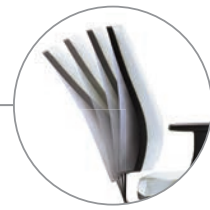

MECANISMOS

Mecanismo Sincron de 4 estágios com regulagem de tensão por manípulo frontal (com opção de regulagem de profundidade do assento). Opção de plataforma giratória para Salas de Reunião (SR).



ESPALDAR

Espaldares Alto e Médio com curvaturas anatômicas para melhor suporte da coluna vertebral.



BRAÇOS

Modelos giratórios com Braços Reguláveis SL, SL New PU, SL New PP (todos com opção de Regulagem Lateral) ou 3D (regulável em altura, avanço e ângulo do apoio PU).



ASSENTO

Assento em espuma injetada com Regulagem de Altura à Gás.



BASES

Opções de Bases em Alumínio ou Nylon, com rodízios de 65mm em Nylon ou PU. Base em Aço com Capa, somente rodízios de 50mm em Nylon ou PU.



ESTRUTURA

Base fixa em estrutura Balanço com Braço Integrado (SI) e Sapata Fixa. Acabamento Cromado ou Preto Universal.

CONFIGURAÇÕES



37001
Giratória Alta
Sincron
Braço 3D
Base Alumínio



37001
Giratória Alta
Sincron
Braço 3D
Base Nylon



37002
Giratória Média
Sincron
Braço SL New PU
Base Nylon



37006
Aproximação Média
Estrutura SI
Braços Integrados

DESENHOS TÉCNICOS

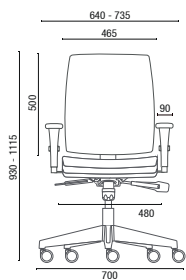

37001 Operacional Alta

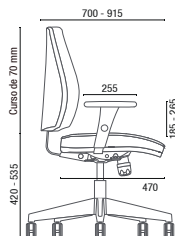

37002 Operacional Média

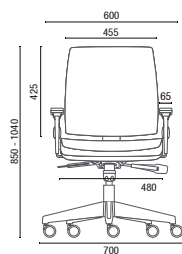

37006 SI Aproximação Média

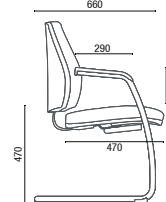
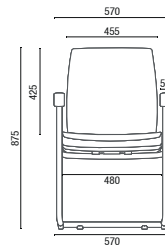
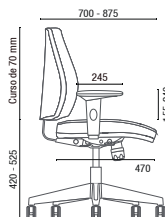

OBS: Medidas extremas obtidas sem o uso de gabarito de carga.



Cavaletti S/A Cadeiras Profissionais
 Rua Dr. Hiram Sampaio, 550
 Erechim/RS Brasil 99.706-461
 Fone/Fax: (54) 3520.4100
 atendimento@cavaletti.com.br
 www.cavaletti.com.br



Procure por nossos produtos certificados FSC*



A marca do manejo florestal responsável



*Produtos Certificados com Rótulo Ecológico (Qualidade - ABNT - Ambiental) ou Norma ABNT NBR 13962, sob consulta ao Departamento Comercial - Setor Público.

Cavaletti

CADEIRAS PROFISSIONAIS



Cavaletti Slim



Cavaletti Slim

Com Design Original Cavaletti, a linha Slim possui encosto e assento com curvaturas anatômicas, mecanismo Sincron com quatro posições de travamento, opção de bases de aço ou alumínio e braços com movimentos 3D. Além de ser uma linha corporativa completa, seu desenho minimalista faz com que a Slim esteja pronta para integrar projetos mais contemporâneos.

CARACTERÍSTICAS



ACABAMENTOS

Diferentes opções de revestimentos: Poliéster, Grid, Space, CEC - Stilo, Vinil e Couro Natural.

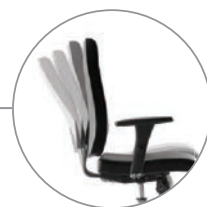

MECANISMOS

Mecanismo Synchron de 4 estágios com regulagem de tensão por manípulo frontal, Mecanismo Relax ou em alguns modelos da linha o Sistema de Reclinação do Encosto (SRE).



ASSENTO

Assento em espuma de alta performance, com Regulagem de Altura à Gás.



BRAÇOS

Modelos giratórios com Braços Reguláveis SL, SL New PU, SL New PP (todos com opção de Regulagem Lateral) ou 3D (regulável em altura, avanço e ângulo do apoio PU).



BASES

Opções de Bases em Alumínio ou Nylon, com rodízios de 65mm em Nylon ou PU. Base Estampada ou Aço com Capa, somente rodízios de 50mm em Nylon ou PU.



ESTRUTURAS

Estruturas fixas com Braços Integrados. Opção de rodízios na estrutura Z. Acabamento Cromado ou Preto Universal.

CONFIGURAÇÕES



18001
Presidente Giratória
Synchron
Braço SL
Base Alumínio



18002
Diretor Giratória
Synchron
Braço SL
Base Estampada



18004 SRE
Executiva Giratória
Sistema Reclinador de Encosto
Braço SL
Base Nylon



18006 Z ROD
Diretor Aproximação
Estrutura Z com Rodízios
Braços Integrados



18006 Z
Diretor Aproximação
Estrutura Z
Braços Integrados



18006 P
Diretor Aproximação
Estrutura P
Braços Integrados



18006 S
Diretor Aproximação
Estrutura S
Braços Integrados



18007 S
Secretária Aproximação
Estrutura S
Braços Integrados



18010
Diretor Longarina
Braço Z Intercalado
Opcional sem braços
Sapata traseira com regulagem

DESENHOS TÉCNICOS

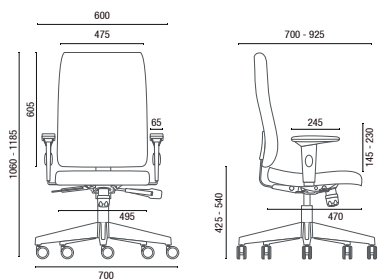

18001 Presidente Giratória

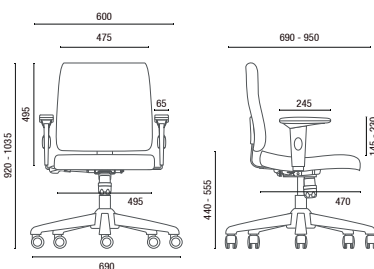

18002 Diretor Giratória

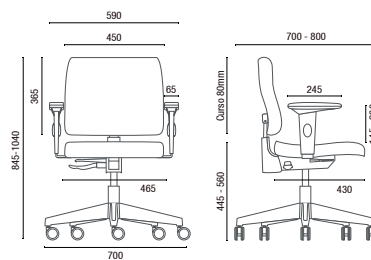

18004 SRE Executiva Giratória

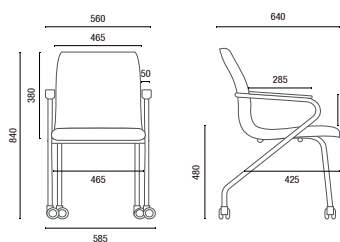

18006 Z ROD Diretor Giratória

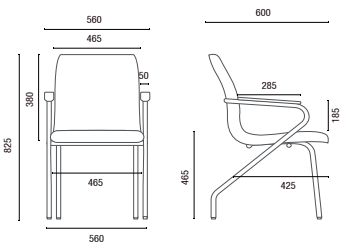

18006 Z Diretor Aproximação

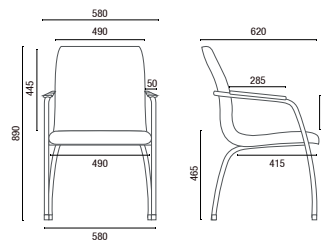

18006 P Diretor Aproximação

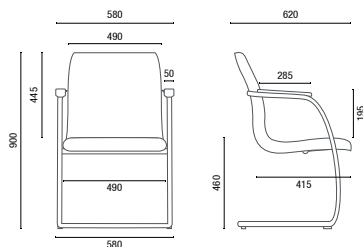

18006 S Diretor Aproximação

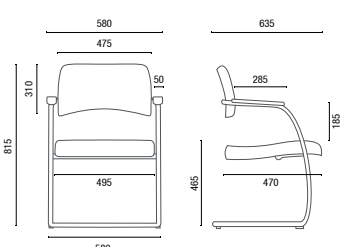

18007 S Secretária Aproximação

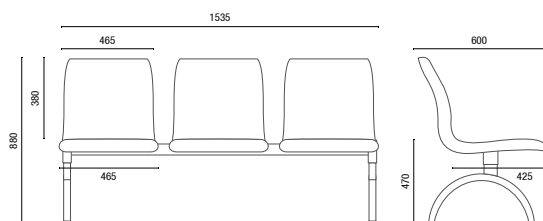

18010 Longarina

Larguras sem Braços: Larguras Braços Z Intercalado:
 2L – 1000mm 2L – 1105mm
 3L – 1535mm 3L – 1660mm
 4L – 2070mm 4L – 2160mm
 5L – 2605mm 5L – 2675mm

OBS: Medidas extremas obtidas sem o uso de gabarito de carga.



Cavaletti S/A Cadeiras Profissionais
 Rua Dr. Hiram Sampaio, 550
 Erechim/RS Brasil 99.706-461
 Fone/Fax: (54) 3520.4100
 atendimento@cavaletti.com.br
 www.cavaletti.com.br



A marca do manejo florestal responsável



*Produtos Certificados com Rótulo Ecológico (Qualidade - ABNT - Ambiental) ou Norma ABNT NBR 13962, sob consulta ao Departamento Comercial - Setor Público.

Cavaletti

CADEIRAS PROFISSIONAIS



Cavaletti Start



Cavaletti Start

A linha Start oferece uma diversidade de modelos que se adaptam a diferentes ambientes. Com alta qualidade e acabamentos selecionados, os modelos Start são ergonômicos e buscam o conforto ideal para o dia-a-dia dos escritórios.

CARACTERÍSTICAS



ACABAMENTOS

Diferentes opções de revestimento: Poliéster, Grid, Space, CEC - Stilo e Vinil.

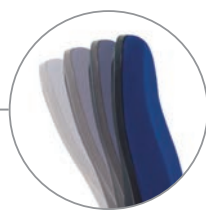

MECANISMOS

Mecanismo Synchron de 4 estágios com regulagem de tensão por manípulo frontal, Sistema de Reclinação do Encosto (SRE) ou Mecanismo Relax (com opção de regulagem de altura do encosto). Nos modelos BG, opção de encosto fixo (mola ou L 2048) ou regulável (L 2048).



ESPALDAR

Espaldares em quatro alturas diferentes: Presidente, Diretor, Executiva e Secretária.



ASSENTO

Assento com regulagem de Altura à Gás, com opções de espuma injetada ou expandida. Nos modelos 4103, 4107, 4110 e 4123 somente espuma injetada. No modelo 4003, somente espuma expandida.



BASES

Opções de Bases em Alumínio ou Nylon, com rodízios de 65mm em Nylon ou PU. Base Estampada ou Aço com Capa, somente rodízios de 50mm em Nylon ou PU.



BRAÇOS

Braços reguláveis SL, SL New PU, SL New PP (todos com opção de Regulagem Lateral) ou 3D (regulável em altura, avanço e ângulo do apoio PU). Braços Fixos nas opções Americano e Loop.



ESTRUTURAS

Estruturas fixas nas opções Arco (A), Palito (P) ou Balanço (S).

CONFIGURAÇÕES



4001
Presidente Giratória
Relax
Braço SL



4002
Diretor Giratória
Relax
Braço SL



4003
Diretor Giratória Extra
Relax
Braço SL com Regulagem Lateral



4006 S
Diretor Aproximação
Estrutura S
Braço Americano



4006 PUE
Diretor Universitária
Prancheta Escamoteável
Braço Americano



4103
Executiva Giratória
Sistema de Reclinação do Encosto
Braço SL New PU



4107 S
Executiva Aproximação
Estrutura S



4123
Executiva Stool
Sistema de Reclinação do Encosto
Braço SL New PU



4004
Secretária Giratória
L2048 com Regulagem
Braço SL



4008 A
Secretária Aproximação
L2048 Fixo
Estrutura Arco



4022
Secretária Stool
L2048 com Regulagem



L2048
Regulagem
de Altura
do Encosto
(4004 e 4022)



4005
Diretor Longarina
Braço Americano Duplo



4110
Executiva Longarina



4005 U / 4110 U
Prancheta Escamoteável
Opcional para 4005 e 4110



4009
Secretária Longarina
L2048 fixo

DESENHOS TÉCNICOS

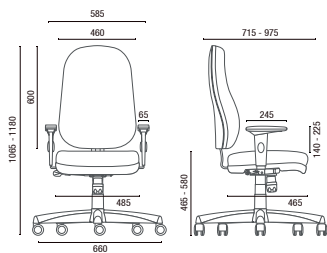

4001 Presidente Giratória

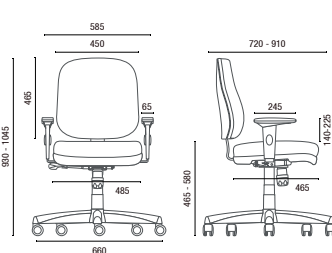

4002 Diretor Giratória

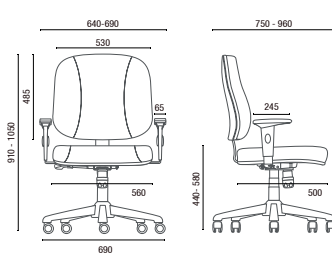

4003 Diretor Giratória Extra

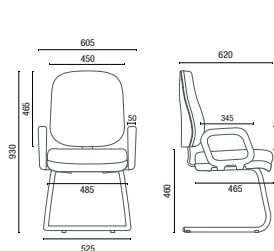

4006 S Diretor Aproximação

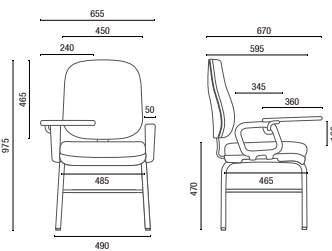

4006 PUE Diretor Universitária

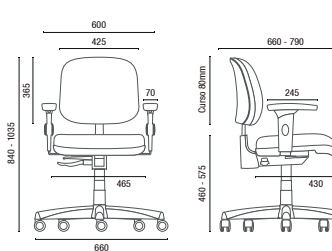

4103 SRE Executiva Giratória

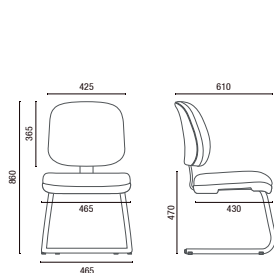

4107 S Executiva Aproximação

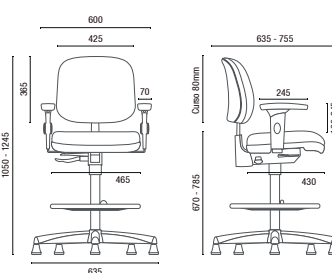

4123 SRE Executiva Stool

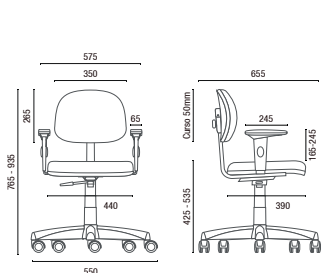

4004 Secretária Giratória

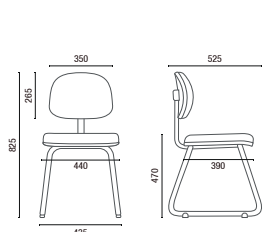

4008 A Secretária Aproximação

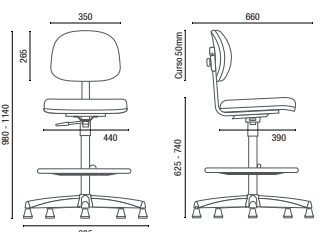

4022 BG Secretária Stool

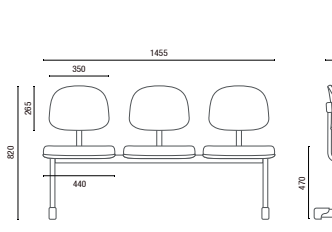

4009 Secretária Longarina
Larguras sem Braço:
2L - 950mm 3L - 1455mm 4L - 1965mm 5L - 2470mm

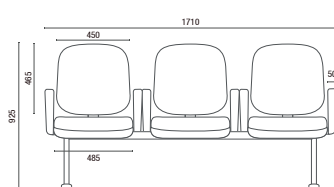

4005 Diretor Longarina
Larguras com Braço Duplo:
2L - 1140mm 3L - 1710mm 4L - 2280mm 5L - 2850mm

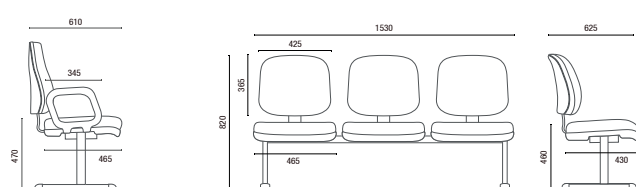

4110 Executiva Longarina
Larguras sem Braço:
2L - 995mm 3L - 1530mm 4L - 2065mm 5L - 2595mm

OBS: Medidas extremas obtidas sem o uso de gabarito de carga.



Cavaletti S/A Cadeiras Profissionais
Rua Dr. Hiram Sampaio, 550
Erechim/RS Brasil 99.706-461
Fone/Fax: (54) 3520.4100
atendimento@cavaletti.com.br
www.cavaletti.com.br



A marca do manejo florestal responsável



*Produtos Certificados com Rótulo Ecológico (Qualidade - ABNT - Ambiental) ou Norma ABNT NBR 13962, sob consulta ao Departamento Comercial - Setor Público.

®

Cavaletti

CADEIRAS PROFISSIONAIS



Cavaletti Stilo



Cavaletti Stilo

Equipada com Sistema Reclinador de Encosto (SRE) Original Cavaletti, a linha Stilo oferece uma série de regulagens ergonômicas ideais para permitir longas jornadas de trabalho com postura adequada, reduzindo o desgaste físico. Seu tamanho compacto ocupa apenas o espaço necessário, facilitando a movimentação intensa do dia-a-dia.

CARACTERÍSTICAS

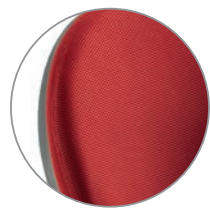

REVESTIMENTOS

Diferentes opções de revestimento: Poliéster, Grid, Space, CEC - Stilo e Vinil.



MECANISMOS

Sistema de Reclinação do Encosto (SRE) ou BG fixa ou com opção de encosto regulável (L 2048) em alguns modelos da linha.



ASSENTO

Assento em espuma injetada com Regulagem de Altura à Gás.



BRAÇOS

Modelos giratórios com Braços Reguláveis SL, SL New PU, SL New PP (todos com opção de Regulagem Lateral) ou 3D (regulável em altura, avanço e ângulo do apoio PU). Braços Fixos nas opções Americano e Loop.



BASE

Base em Aço com Capa. Rodízios de 50mm em Nylon ou PU.



ESTRUTURAS

Estruturas fixas nas opções Arco (A), Palito (P) ou Balanço (S). Acabamento com pintura Prata ou Preto Universal.



CONFIGURAÇÕES



8203 SRE
Executiva Giratória
Sistema Reclinador de Encosto
Braço SL New PU



8203
Executiva Giratória
Flange
Braço SL New PU
Suporte de Encosto L2048



L2048
Regulagem
de Altura
do Encosto



8207 S
Executiva Aproximação
Estrutura S



8223
Executiva Stool
Suporte do Encosto L2048



8210
Executiva Longarina

DESENHOS TÉCNICOS

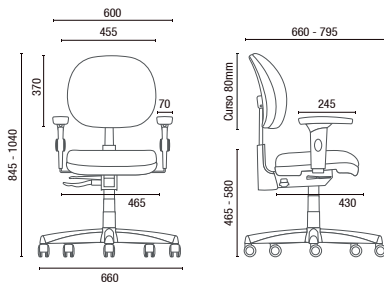

8203 SRE Executiva Giratória

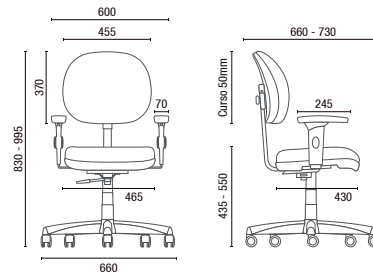

8203 BG Executiva Giratória

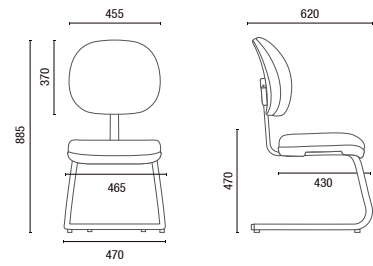

8207 S Executiva Aproximação

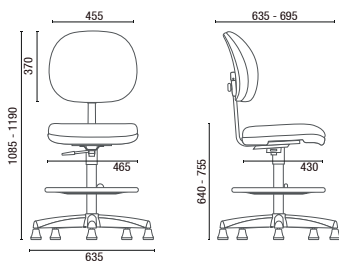

8223 Executiva Stool

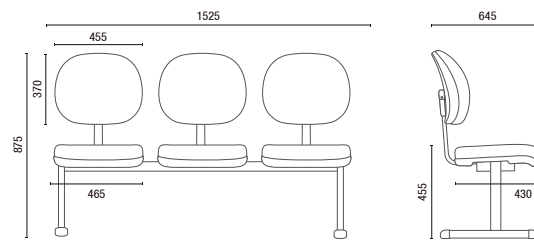

8210 Executiva Longarina

Larguras sem Braços:

2L - 1000mm

3L - 1525mm

4L - 2045mm

5L - 2585mm

OBS: Medidas extremas obtidas sem o uso de gabarito de carga.



Cavaletti S/A Cadeiras Profissionais
Rua Dr. Hiram Sampaio, 550
Erechim/RS Brasil 99.706-461
Fone/Fax: (54) 3520.4100
atendimento@cavaletti.com.br
www.cavaletti.com.br



Procure por nossos produtos certificados FSC®



A marca do manejo florestal responsável

*Produtos Certificados com Rótulo Ecológico (Qualidade - ABNT - Ambiental) ou Norma ABNT NBR 13962, sob consulta ao Departamento Comercial - Setor Público.

Cavaletti®

CADEIRAS PROFISSIONAIS



Cavaletti StartPlus



Cavaletti StartPlus

Com opções diferenciadas de acabamentos, a linha Start Plus alia cuidado artesanal à tecnologia de ponta. São três padronagens de costuras disponíveis que completam ambientes sofisticados de forma sutil, porém marcante.

CARACTERÍSTICAS



REVESTIMENTOS

Diferentes opções de revestimento: Poliéster, Grid, Space, CEC - Stilo e Vinil. Duas opções de costura conforme modelo (3000 e 6000).

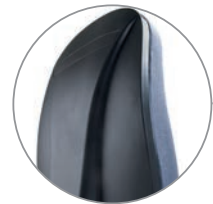

ESPALDAR

Espaldar em quatro alturas diferentes conforme modelos: Presidente, Diretor, Executiva e Secretária.



ASSENTO

Assento em espuma injetada com Regulagem de Altura à Gás.



BASES

Opções de Bases em Alumínio ou Nylon, com rodízios de 65mm em Nylon ou PU. Base em Aço com Capa, somente rodízios de 50mm em Nylon ou PU.



MECANISMOS

Mecanismo Synchron de 4 estágios com regulagem de tensão por manípulo frontal, Sistema de Reclinação do Encosto (SRE) ou Mecanismo Relax (com opção de regulagem de altura do encosto). Nos modelos BG, opção de encosto fixo (mola ou L 2048) ou regulável (L 2048).



BRAÇOS

Modelos giratórios com Braços Reguláveis SL, SL New PU, SL New PP (todos com opção de Regulagem Lateral) ou 3D (regulável em altura, avanço e ângulo do apoio PU). Braços Fixos nas opções Americano e Loop.



ESTRUTURAS

Estruturas fixas nas opções Arco (A), Palito (P) ou Balanço (S). Acabamento Cromado ou Pintura em Preto Universal.

CONFIGURAÇÕES



3001
Presidente Giratória
Relax
Braço SL



3002
Diretor Giratória
Relax
Braço SL



3006 S
Diretor Aproximação
Estrutura S
Braço Americano



3004 SRE
Secretária Giratória
Sistema Reclinador de Encosto
Braço SL New PU



L2048
Regulagem
de Altura
do Encosto



3008 S
Secretária Aproximação
Estrutura S



3022
Secretária Stool
L2048 com Regulagem



3005
Diretor Longarina
Braço Americano Duplo



3009
Secretária Longarina



6001
Presidente Giratória
Relax
Braço SL



6002
Diretor Giratória
Relax
Braço SL



6006 S
Diretor Aproximação
Estrutura S
Braço Americano



6104 SRE
Executiva Giratória
Sistema Reclinador de Encosto
Braço SL New PU

DESENHOS TÉCNICOS

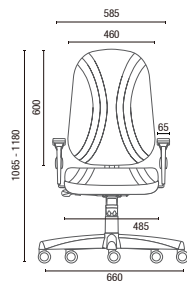

3001 Presidente Giratória

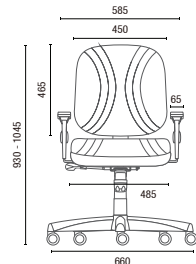
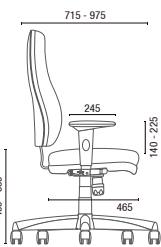

3002 Diretor Giratória

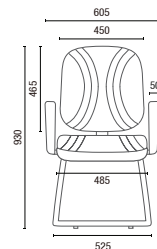
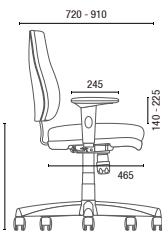

3006 S Diretor Aproximação

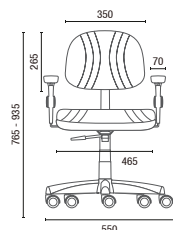
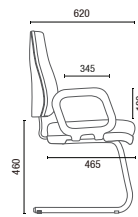

3004 Secretária Giratória

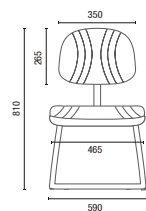
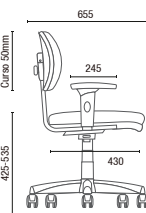

3008 S Secretária Aproximação

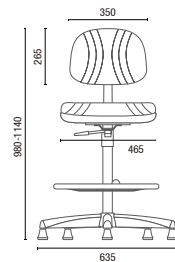
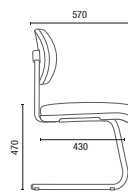

30022 BG Secretária Stool

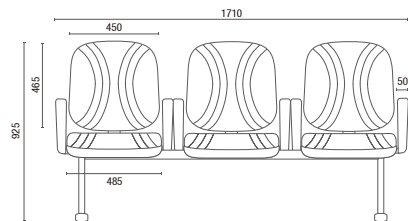
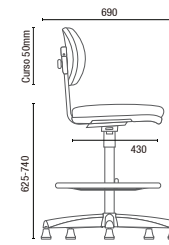

3005 Diretor Longarina

Largura Braço Duplo:
2L - 1140mm 3L - 1710mm 4L - 2280mm 5L - 2580mm

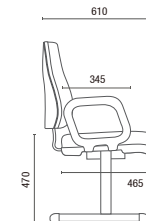

3009 Secretária Longarina

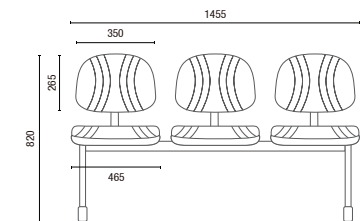

Largura sem Braço:
2L - 950mm 3L - 1455mm 4L - 1965mm 5L - 2470mm

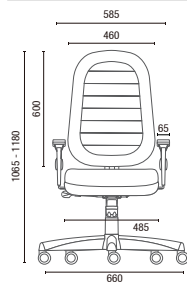
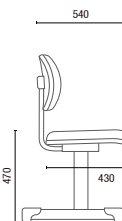

6001 Presidente Giratória

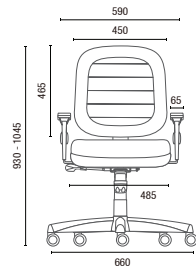
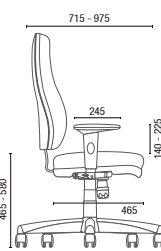

6002 Diretor Giratória

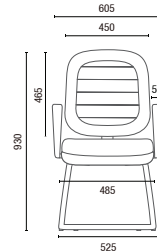
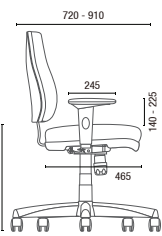

6006 S Diretor Aproximação

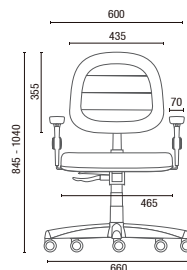
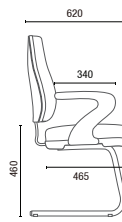

6104 Executiva Giratória

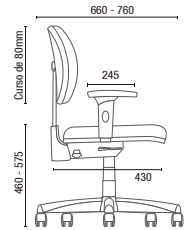

OBS: Medidas extremas obtidas sem o uso de gabarito de carga.



Cavaletti S/A Cadeiras Profissionais
Rua Dr. Hiram Sampaio, 550
Erechim/RS Brasil 99.706-461
Fone/Fax: (54) 3520.4100
atendimento@cavaletti.com.br
www.cavaletti.com.br



Procure por nossos produtos certificados FSC®



A marca do manejo florestal responsável



*Produtos Certificados com Rótulo Ecológico (Qualidade - ABNT - Ambiental) ou Norma ABNT NBR 13962, sob consulta ao Departamento Comercial - Setor Público.

Cavaletti[®]

CADEIRAS PROFISSIONAIS



Cavaletti Aura



Cavaletti Aura

Cavaletti Aura sintetiza precisão e inspiração. Tecnologia e design contemporâneo. Minimalismo e, ao mesmo tempo, riqueza em detalhes. Por essa pluralidade tão presente, a Aura é um produto versátil, com capacidade de adaptação aos mais diversos projetos e ambientes.

DESIGN PRECISO, FORMAS INSPIRADORAS.

Cavaletti Aura combina tecnologia e desenho harmônico, sofisticação e versatilidade. Um produto minimalista no design, mas com inúmeros detalhes importantes que você precisa conhecer.



CARACTERÍSTICAS



ENCOSTOS

Opções de encosto alto ou baixo, permitindo seu uso e composição em diversos ambientes.

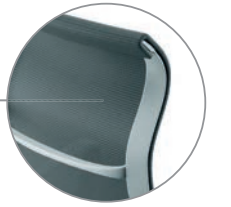

REVESTIMENTO

Uma membrana única de alta resistência é responsável por proporcionar conforto e perfeito acabamento. Disponível nas cores Preto, Cinza ou em tecido.



MECANISMO

Mecanismo do tipo Sincron, com sistema de travamento na posição de trabalho ou em livre flutuação e regulação automática da tensão, ajustando-se ao peso do usuário sem a necessidade de ajuste manual.

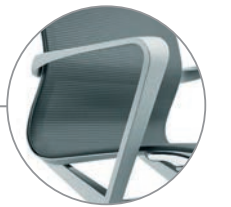

BRAÇOS

Os braços são fixos e acompanham as curvas marcantes, que vão desde a estrutura do encosto até a base do assento.



BASES

Opções de Bases em Alumínio Polido e nas cores Preto e Cinza, com Rodízios de 60mm mistos.

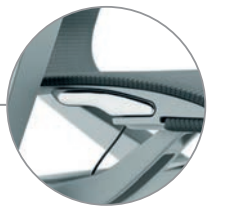

REGULAGEM

Os controles de regulagens são harmonicamente integrados ao desenho do produto.





CONFIGURAÇÕES

Confira abaixo as opções de combinações possíveis para Cavaletti Aura e escolha a sua.



44.101
Giratória Multitask
Tecido
Base Alumínio Polido



44.101
Giratória Multitask
Tela Preta
Base Preta



44.101
Giratória Multitask
Tela Cinza
Base Cinza



44.102
Giratória Multitask
Tecido
Base Alumínio Polido



44.102
Giratória Multitask
Tela Preta
Base Preta



44.102
Giratória Multitask
Tela Cinza
Base Cinza

BASES

São 3 opções de bases diferentes: em Alumínio Polido e nas cores Preto e Cinza.



Alumínio Polido



Preto



Cinza

REVESTIMENTOS

A Cavaletti Aura possui 3 revestimentos diferentes: Tela Preta, Tela Cinza e um revestimento em Tecido. Confira abaixo as texturas de cada material.

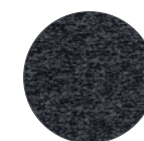

Tecido*



Tela Preta

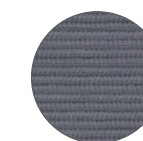

Tela Cinza

*O Revestimento em Tecido pode ser utilizado somente com a estrutura Preta.

DESENHOS TÉCNICOS

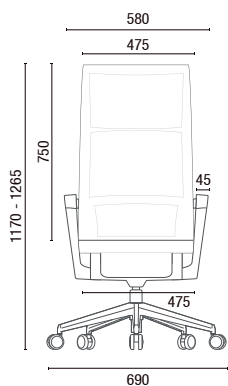

44.101 **Giratória Multitask**

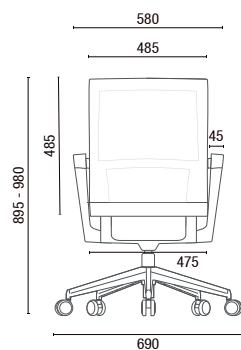
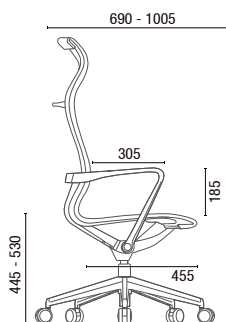

44.102 **Giratória Multitask**

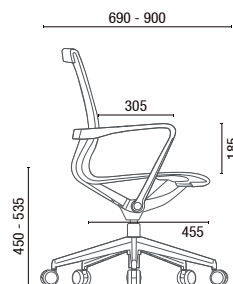

OBS: Medidas extremas obtidas sem o uso de gabarito de carga.



Cavaletti S/A Cadeiras Profissionais
 Rua Dr. Hiram Sampaio, 550
 Erechim/RS Brasil 99.706-461
 Fone/Fax: (54) 3520.4100
 atendimento@cavaletti.com.br
 www.cavaletti.com.br



Cavaletti®

CADEIRAS PROFISSIONAIS



Cavaletti Leef

Cavaletti Leef

Cavaletti Leef é um produto de design autoral, com linhas minimalistas e ao mesmo tempo cheias de personalidade. Uma cadeira marcada pelo visual icônico e uma combinação perfeita de recursos inovadores, capazes de garantir o máximo conforto, seja para usos de curta ou longa duração.



CARACTERÍSTICAS

A união entre as características técnicas e os detalhes cuidadosamente projetados fazem da Leef uma cadeira única, principalmente quando você a customiza de acordo com o seu projeto.



MECANISMOS

Mecanismo Synchron de 4 estágios com regulagem de tensão por manípulo frontal e regulagem de profundidade do assento.



ENCOSTO FLEXÍVEL

Encosto com estrutura maleável, capaz de se adaptar à mudança de posição.

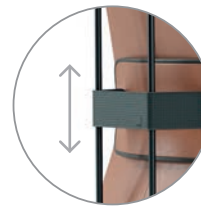

APOIO LOMBAR

Apoio lombar ajustável (curso de 280mm) à anatomia do corpo.



BASE

Opções de Bases: Twin (Alumínio em dois tons) ou Up (Nylon), com Rodízios de 65mm em Nylon ou PU.

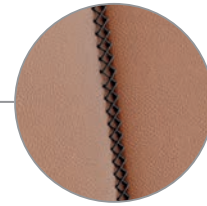

REVESTIMENTOS

Revestimentos em Couro Natural, CEC - Stilo, Haven e Politex, com opções de costura contrastantes e sutis para cada cor.



BRAÇOS

Braço 4D (regulável em 4 dimensões) ou Braço 3D (regulável em altura, avanço e ângulo do apoio PU).



ASSENTO

Regulagem de profundidade em 6 estágios (curso de 50mm).

SIMPLESMENTE INUSITADA

Com design leve e distintivo, a cadeira Leef pode ser utilizada tanto para uso diretivo quanto operativo.



OBS: Produtos nesta imagem com revestimento em CEC - Stilo Fendi com Costura Cinza Cód. 754 e Marrom com Costura Cobre Cód. 750.



Parceiro da Cavaletti desde 2011, Marc Sapetti nasceu em Andorra e formou-se em design industrial em Barcelona. Nos anos seguintes trabalhou em escritórios relevantes na Europa, culminando com a criação do seu próprio escritório. Hoje, a Sapetti Design Consultancy é um estúdio multipremiado junto com a Cavaletti. Entre os prêmios, incluem-se o IF Awards (Cavaletti Go) e o Good Design Award (Cavaletti Idea e Cavaletti Vélo).

OBS: Produto nestas imagens e na capa deste catálogo com revestimento em Couro Natural Caramelo com Costura Preto Cód. 702.

CONFIGURAÇÕES



45.101
Giratória Operativa
Sincron RP
Braços 4D-CA
Base Twin (Alumínio)



45.101
Giratória Operativa
Sincron RP
Braços 3D
Base Twin (Alumínio)



45.101
Giratória Operativa
Sincron RP
Braços 4D-CA
Base Up (Nylon)

OBS: Produtos nestas imagens com revestimento em Couro Natural Preto com Costura Cobre Cód. 700.

REVESTIMENTOS

Use sua imaginação para customizar seu ambiente ao configurar cadeiras únicas. Confira abaixo as texturas de cada revestimento disponível. São diversas opções de cores entre Haven, CEC - Stilo, Couro Natural, Politex e Grid.

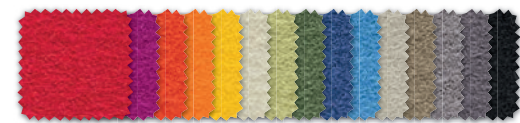

HAVEN
15 Cores.

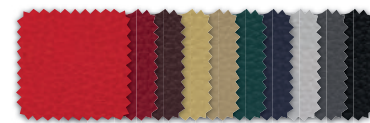

CEC - STILO
10 Cores.



COURO NATURAL
02 Cores.

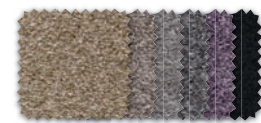

POLITEX
06 Cores.

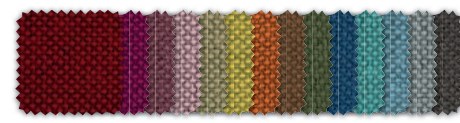

GRID
14 Cores.

COMBINAÇÕES

Escolha a combinação de revestimento e padrão de costura que melhor combina com o seu projeto. São 94 opções disponíveis. Para especificar a combinação, utilize os códigos abaixo. Exemplo: Couro Preto + Costura Cobre = Cód. 700 (Revestimento + Costura = Código).

Couro

REVESTIMENTO + COSTURA	PRETO COBRE	CÓD 700	PRETO PRETO	CÓD 701	CARAMELO PRETO	CÓD 702	CARAMELO COBRE	CÓD 703
------------------------	-------------	---------	-------------	---------	----------------	---------	----------------	---------

Politex

REVESTIMENTO + COSTURA	CAFÉ C/ LEITE COBRE	CÓD 734	CAFÉ C/ LEITE CINZA ESCURO	CÓD 735	MARRROM AREIA	CÓD 736	MARRROM PRETO	CÓD 737	CINZA METAL VERMELHO	CÓD 738	CINZA METAL CINZA ESCURO	CÓD 739	CINZA ESCURO VERMELHO	CÓD 740	CINZA ESCURO CINZA ESCURO	CÓD 741
REVESTIMENTO + COSTURA	LILÁS ROSA	CÓD 742	LILÁS ROXO	CÓD 743	PRETO COBRE	CÓD 744	PRETO PRETO	CÓD 745								

Haven

REVESTIMENTO + COSTURA	VERMELHO ROSA	CÓD 722	VERMELHO VERMELHO	CÓD 723	MAGENTA ROSA	CÓD 724	MAGENTA ROXO	CÓD 725	TERRACOTA PRETO	CÓD 720	TERRACOTA COBRE	CÓD 721	LARANJA PRETO	CÓD 718	LARANJA LARANJA	CÓD 719
	AMARELO CINZA ESCURO	CÓD 730	AMARELO AMARELO	CÓD 731	NEVE OLIVA	CÓD 712	NEVE AREIA	CÓD 713	CAMPO PRETO	CÓD 714	CAMPO OLIVA	CÓD 715	SAVANA AREIA	CÓD 716	SAVANA OLIVA	CÓD 717
	CREPÚSCULO CINZA CLARO	CÓD 728	CREPÚSCULO AZUL ESCURO	CÓD 729	CÉU COBRE	CÓD 726	CÉU AZUL CLARO	CÓD 727	AREIA COBRE	CÓD 710	AREIA AREIA	CÓD 711	TERRA AREIA	CÓD 732	TERRA CINZA ESCURO	CÓD 733
	CONCRETO AZUL CLARO	CÓD 708	CONCRETO CINZA ESCURO	CÓD 709	ASFALTO AZUL CLARO	CÓD 706	ASFALTO CINZA ESCURO	CÓD 707	PRETO COBRE	CÓD 704	PRETO PRETO	CÓD 705				

CEC - Stilo

REVESTIMENTO + COSTURA	VERMELHO PRETO	CÓD 746	VERMELHO VERMELHO	CÓD 747	VINHO ROSA	CÓD 748	VINHO ROXO	CÓD 749	MARRROM COBRE	CÓD 750	MARRROM PRETO	CÓD 751	BEGE OLIVA	CÓD 752	BEGE AREIA	CÓD 753
	FENDI CINZA CLARO	CÓD 754	FENDI OLIVA	CÓD 755	VERDE CINZA CLARO	CÓD 756	VERDE PRETO	CÓD 757	AZUL AZUL CLARO	CÓD 758	AZUL PRETO	CÓD 759	BRANCO PRETO	CÓD 760	BRANCO CINZA CLARO	CÓD 761
	CINZA CINZA CLARO	CÓD 762	CINZA PRETO	CÓD 763	PRETO COBRE	CÓD 764	PRETO PRETO	CÓD 765								

GRID

REVESTIMENTO + COSTURA	VERMELHO PERSA ROSA	CÓD 813	VERMELHO PERSA VERMELHO	CÓD 814	ROSA PITAYA ROSA	CÓD 815	ROSA PITAYA ROXO	CÓD 816	ROSA MALVA ROSA	CÓD 809	ROSA MALVA CINZA ESCURO	CÓD 810	ROSA CAMÉLIA ROXO	CÓD 807	ROSA CAMÉLIA ROSA	CÓD 808
	LARANJA AMBAR PRETO	CÓD 817	LARANJA AMBAR LARANJA	CÓD 818	AMARELO SICLIANO AZUL ESCURO	CÓD 819	AMARELO SICLIANO AMARELO	CÓD 820	VERDE FLORESTA AREIA	CÓD 811	VERDE FLORESTA OLIVA	CÓD 812	AZUL CARIBE ROXO	CÓD 821	AZUL CARIBE AZUL MÉDIO	CÓD 822
	AZUL INFINITO AZUL ESCURO	CÓD 823	AZUL INFINITO COBRE	CÓD 824	AZUL COBALTO AZUL CLARO	CÓD 825	AZUL COBALTO AZUL ESCURO	CÓD 826	BEGE MARFIM AZUL ESCURO	CÓD 827	BEGE MARFIM OLIVA	CÓD 828	MARRROM AVELÁ CINZA CLARO	CÓD 829	MARRROM AVELÁ COBRE	CÓD 830
	CINZA NÉVOA LARANJA	CÓD 831	CINZA NÉVOA CINZA CLARO	CÓD 832	CINZA TITÂNIO CINZA CLARO	CÓD 833	CINZA TITÂNIO CINZA ESCURO	CÓD 834								

OBS: As cores e revestimentos expostos neste catálogo são ilustrativos, e devem ser utilizados somente como referência. Para maiores informações, consulte mostruário.

DESENHOS TÉCNICOS

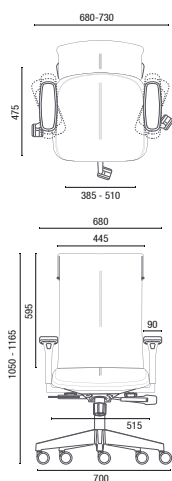

45.101 **Giratória Operativa**
Braços 4D-CA
Base Twin (Alumínio)

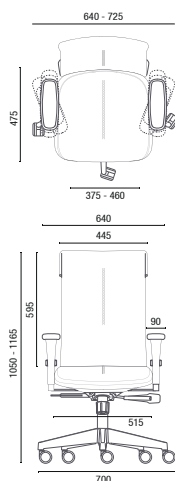

45.101 **Giratória Operativa**
Braços 3D
Base Twin (Alumínio)

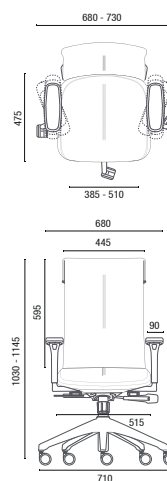

45.101 **Giratória Operativa**
Braços 4D-CA
Base Up (Nylon)

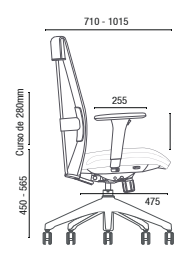
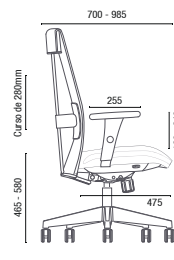
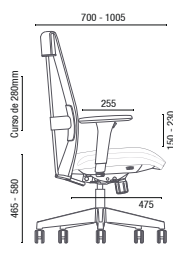

OBS: Medidas extremas obtidas sem o uso de gabarito de carga.



Cavaletti S/A Cadeiras Profissionais
Rua Dr. Hiram Sampaio, 550
Erechim/RS Brasil 99.706-461
Fone/Fax: (54) 3520.4100
atendimento@cavaletti.com.br
www.cavaletti.com.br



Cavaletti®

CADEIRAS PROFISSIONAIS



Cavaletti C4

Cavaletti C4

Funções ergonômicas avançadas e acabamento com detalhes em alumínio fazem da Cavaletti C4 uma alternativa ideal para espaços diretivos de alto padrão.



ACESSÓRIOS

Opção de Apoio de Cabeça fixo.
Disponível em Preto.



MECANISMOS

Mecanismo Sincron de 4 estágios com regulagem de profundidade do assento e regulagem automática da tensão, ajustando-se ao peso do usuário sem a necessidade de ajuste manual.



ESPALDAR

Espaldar em tela, com Apoio Lombar estofado e regulável. Estrutura aparente em Alumínio Polido.



BRAÇOS

Braço 3D regulável em altura, movimento horizontal frontal ou lateral. Apoio em PU *soft touch*.



BASES

Opções de Bases em Alumínio ou Nylon, com rodízios de 65mm em Nylon ou PU.



ASSENTO

Assento em espuma injetada com Regulagem de Profundidade e Regulagem de Altura à Gás. Revestimentos em Poliéster, Grid, Haven, CEC - Stilo, Space, Vinil e Couro Natural.



29001
Presidente Giratória
Sincron
Braços 3D
Base em Nylon



29001 AC
Presidente Giratória
Sincron
Braços 3D
Base em Alumínio
Apoio de Cabeça

DESENHOS TÉCNICOS

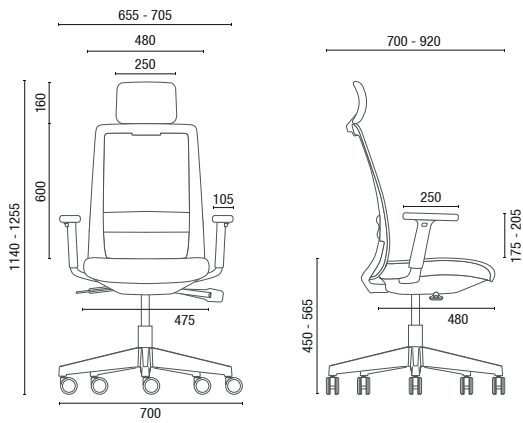

29001 AC Presidente Giratória com Apoio de Cabeça

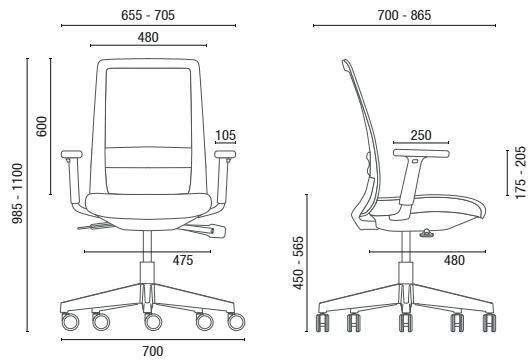

29001 Presidente Giratória

OBS: Medidas extremas obtidas sem o uso de gabarito de carga.



Cavaletti S/A Cadeiras Profissionais
 Rua Dr. Hiram Sampaio, 550
 Erechim/RS Brasil 99.706-461
 Fone/Fax: (54) 3520.4100
 atendimento@cavaletti.com.br
 www.cavaletti.com.br





Cavaletti®

CADEIRAS PROFSSIONAIS

Cavaletti C3

Cavaletti C3

Simplicidade e ergonomia. Atributos essenciais de uma cadeira para espaços de trabalho de alta exigência, onde a alta performance é o objetivo mais importante.



28001
Presidente Giratória
Sincron
Braços 4D
Base em Aço com Capa



28001
Presidente Giratória
Sincron
Braços 4D
Base em Nylon



28001 AC
Presidente Giratória
Sincron
Braços 4D
Base em Alumínio
Apoio de Cabeça

CARACTERÍSTICAS



ACESSÓRIOS
Opção de Apoio de Cabeça com regulagem de altura automática e movimentos 3D permitindo melhor ajuste e acomodação. Disponível em Preto.



MECANISMOS
Mecanismo Sincron de 4 estágios com regulagem de profundidade do assento e regulagem automática da tensão, ajustando-se ao peso do usuário sem a necessidade de ajuste manual.



ESPAJDAR
Espaldar em tela preta com Apoio Lombar flexível e regulável.



BRAÇOS
Braço 4D, regulável em altura, movimento horizontal frontal, lateral e giro no plano horizontal. Apoio em PU *soft touch*.



BASES
Opções de Bases em Alumínio ou Nylon, com rodízios de 65mm em Nylon ou PU. Base em Aço com Capa, somente rodízios de 50mm em Nylon ou PU.



ASSENTO
Assento em espuma injetada com Regulagem de Profundidade e Regulagem de Altura à Gás. Revestimentos em Poliéster, Grid, Haven, CEC - Stilo, Space, Vinil e Couro Natural.

DESENHOS TÉCNICOS

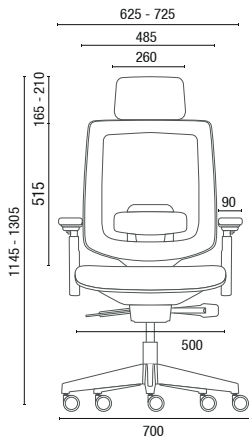

28001 AC **Presidente Giratória com Apoio de Cabeça**

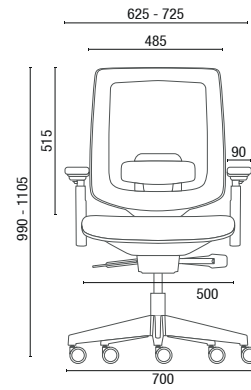
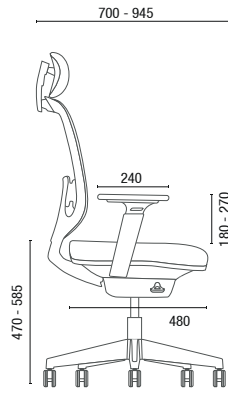

28001 **Presidente Giratória**

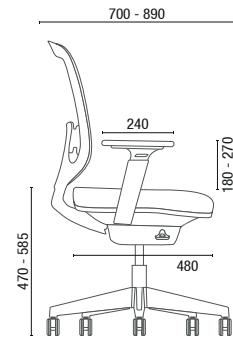

OBS: Medidas extremas obtidas sem o uso de gabarito de carga.



Cavaletti S/A Cadeiras Profissionais
 Rua Dr. Hiram Sampaio, 550
 Erechim/RS Brasil 99.706-461
 Fone/Fax: (54) 3520.4100
 atendimento@cavaletti.com.br
 www.cavaletti.com.br





Cavaletti[®]

CADEIRAS PROFISSIONAIS

Cavaletti Way

Cavaletti Way

A linha Cavaletti Way oferece design inspirado nas silhuetas esbeltas, elegantes e com personalidade marcante. Apresenta três opções de altura de espaldar para atender todos os tipos de ambientes diretivos.



ESPALDAR
Espaldar 185 mm mais alto.
Suporte interno em tela em todos os modelos.



APOIO DE CABEÇA
Maior suporte da região cervical (modelo 19001 L).



BRAÇOS AJUSTÁVEIS
Braços Reguláveis SL, SL New PU, SL New PP (todos com opção de Regulagem Lateral) ou 3D (regulável em altura, avanço e ângulo do apoio PU).



DETALHES
Costura com desenho exclusivo.



MECANISMO
Mecanismo Synchron de 4 estágios com regulagem de tensão por manipulo frontal (com opção de regulagem de profundidade do assento).



BASES
Opções de Bases em Alumínio ou Nylon, com rodízios de 65mm em Nylon ou PU. Base em Aço com Capa, somente rodízios de 50mm em Nylon ou PU.



ESTRUTURAS
Estrutura fixa balanço com braços integrados (SI). Acabamento em pintura Preto Universal ou Cromado.

CONFIGURAÇÕES



19001 L
Presidente Giratória L
Synchron
Braços 3D
Base Alumínio
Apoio de Cabeça



19001
Presidente Giratória
Synchron
Braços SL New PU
Base Alumínio



19002
Diretor Giratória
Synchron
Braços 3D
Base Alumínio



19006 SI
Diretor Aproximação
Estrutura SI
Braços Integrados

DESENHOS TÉCNICOS

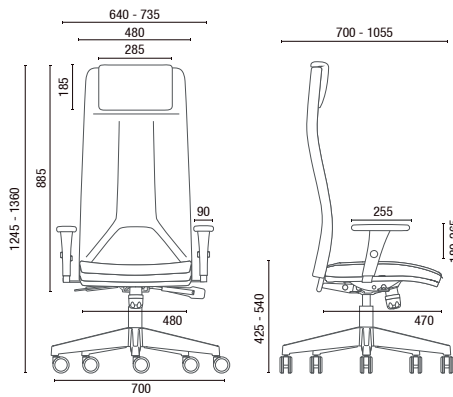

19001 L Presidente Giratória

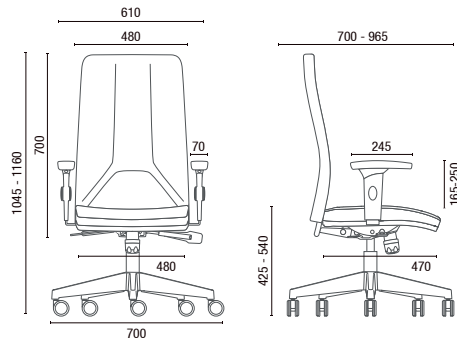

19001 Presidente Giratória

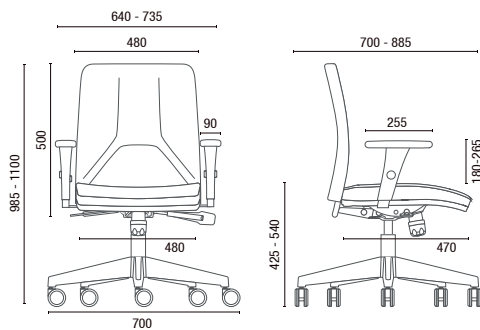

19002 Diretor Giratória

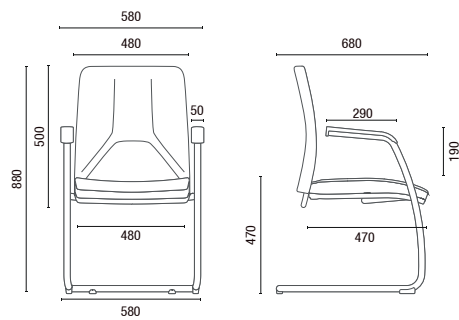

19006 SI Diretor Aproximação

OBS: Medidas extremas obtidas sem o uso de gabarito de carga.



Cavaletti S/A Cadeiras Profissionais
Rua Dr. Hiram Sampaio, 550
Erechim/RS Brasil 99.706-461
Fone/Fax: (54) 3520.4100
atendimento@cavaletti.com.br
www.cavaletti.com.br



Procure por nossos produtos certificados FSC®



A marca do manejo florestal responsável



Cavaletti®

CADEIRAS PROFISSIONAIS



Cavaletti Essence



Cavaletti Essence

Em um ambiente diretivo, essencial é reunir em um único produto, acabamentos refinados, dimensões generosas e ajustes ergonômicos para garantir amplo conforto em todas as decisões do dia.

CARACTERÍSTICAS



ESPALDAR
Espaldar com 750mm no modelo Presidente.



MECANISMOS
Mecanismo Synchron de 3 estágios com regulagem de tensão por manipulo frontal.



REVESTIMENTOS
Disponível em CEC - Stilo ou 100% Couro Natural.



BRAÇOS
Braços exclusivos, fixos em Alumínio ou 4D em PU Soft Touch (regulagem em altura, profundidade, afastamento lateral e rotação do apoio).

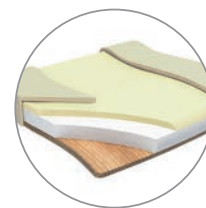

SUPORTE
Assento com duas densidades de espuma, distribuídas conforme a área de apoio.



ASSENTO
Assento com Regulagem de Profundidade e Regulagem de Altura à Gás.



BASES
Opções de Bases em Alumínio ou Nylon, com rodízios de 65mm em Nylon ou PU.



ESTRUTURAS
Base fixa com rodízios frontais para melhor movimentação. Acabamento Cromado ou Preto Universal.

CONFIGURAÇÕES



20.501
Presidente Giratória
Synchron RP
Braços fixos em Alumínio
Base Alumínio



20.502
Diretor Giratória
Synchron RP
Braços fixos em Alumínio
Base Alumínio



20.506 S
Diretor Aproximação
Estruturas com rodízios frontais
Braços fixos em Alumínio



Mobilidade
Rodízios frontais



20.501
Presidente Giratória
Synchron RP
Braços 4D
Base Nylon



20.502
Diretor Giratória
Synchron RP
Braços 4D
Base Nylon



20.506 S
Diretor Aproximação
Estruturas com rodízios frontais
Braços 4D

REVESTIMENTOS

Couro Natural

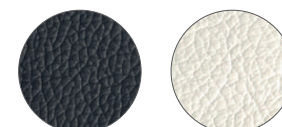

Preto

Branco

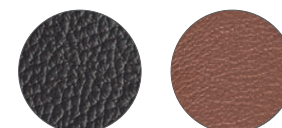

Marrom

Caramelo

CEC - Stilo



Preto

Cinza

Branco

Bege

Fendi



Vermelho

Vinho

Marrom

Verde

Azul

DESENHOS TÉCNICOS

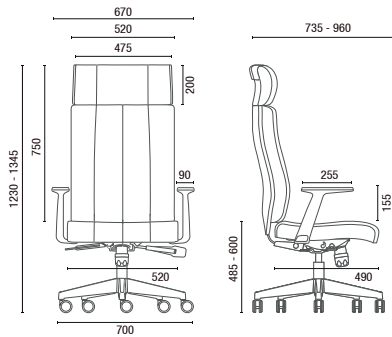

20.501 **Presidente Giratória**
Braços fixos em Alumínio

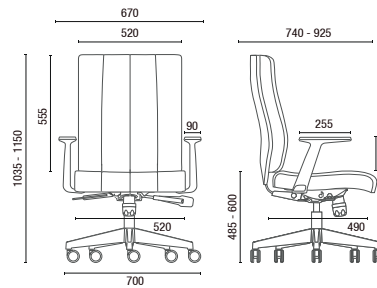

20.502 **Diretor Giratória**
Braços fixos em Alumínio

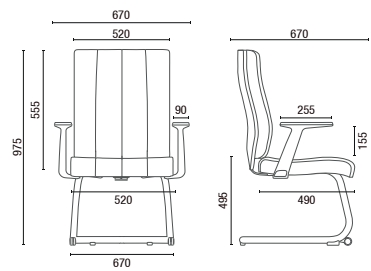

20.506 S **Diretor Aproximação**
Braços fixos em Alumínio

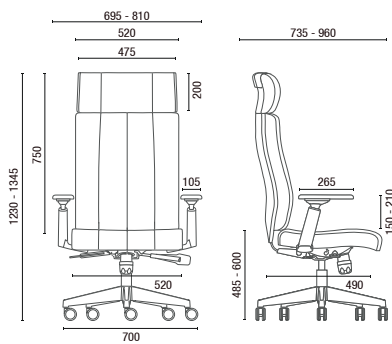

20.501 **Presidente Giratória**
Braços 4D

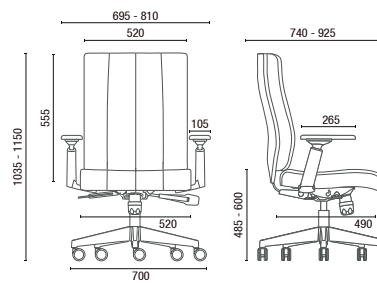

20.502 **Diretor Giratória**
Braços 4D

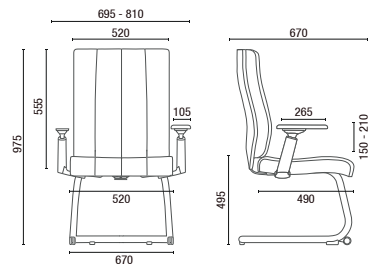

20.506 S **Diretor Aproximação**
Braços 4D

OBS: Medidas extremas obtidas sem o uso de gabarito de carga.



Cavaletti S/A Cadeiras Profissionais
Rua Dr. Hiram Sampaio, 550
Erechim/RS Brasil 99.706-461
Fone/Fax: (54) 3520.4100
atendimento@cavaletti.com.br
www.cavaletti.com.br



Cavaletti

CADEIRAS PROFISSIONAIS



Cavaletti Prime
Cavaletti Master

CARACTERÍSTICAS



REVESTIMENTO
Modelos com revestimento em Couro Natural Preto.



MECANISMOS
Mecanismo Synchron Excêntrico de 5 estágios com regulagem de tensão por manípulo frontal.



BRAÇOS
Braços Articulados em Alumínio com apoio em PU.



BASES
Base em Alumínio com desenho exclusivo. Rodízios 60mm em PU.



PRIME 20200



ASSENTO
Em espuma multidensidade, com Regulagem de Altura à Gás;



ESTRUTURA
Estrutura fixa na opção Balanço (S) com acabamento Cromado.



REVESTIMENTOS
Revestimentos em CEC - Stilo, Vinil e Couro Natural Preto. Opções de costura conforme modelo (20000 ou 20100).



MECANISMOS
Mecanismo Relax com sistema de travamento na posição de trabalho ou livre flutuação, com regulagem de tensão por manípulo frontal.



BRAÇOS
Braço Fixo Cromado com acabamento em PP.



PRIME 20100
MASTER 20000



BASES
Opções de Bases Estampada, Alumínio e Elíptica (acabamento cromado), com rodízios de 50mm em Nylon ou PU.

Cavaletti Prime

Ser prime é ter direito ao que há de melhor. Por isso, as poltronas para áreas diretivas da linha Prime são produzidas com atenção aos detalhes, utilizando materiais nobres e construção primorosa.



CONFIGURAÇÕES

PRIME 20200



20201
Presidente Giratória
Sincron Excêntrico
Braços Articuláveis
Base Alumínio



20202
Diretor Giratória
Sincron Excêntrico
Braços Articuláveis
Base Alumínio



20206 S
Diretor Aproximação
Estrutura S
Braços Articuláveis

PRIME 20100



20101
Presidente Giratória
Relax
Braços Fixos
Base Estampada



20102
Diretor Giratória
Relax
Braços Fixos
Base Estampada



20103
Diretor Giratória Extra
Relax
Braços Fixos
Base Estampada



20106 S
Diretor Aproximação
Estrutura S
Braços Fixos

MASTER 20000



20001
Presidente Giratória
Relax
Base Alumínio



20002
Diretor Giratória
Relax
Base Estampada



20006 S
Diretor Aproximação
Estrutura Balanço (S)

DESENHOS TÉCNICOS

PRIME 20200

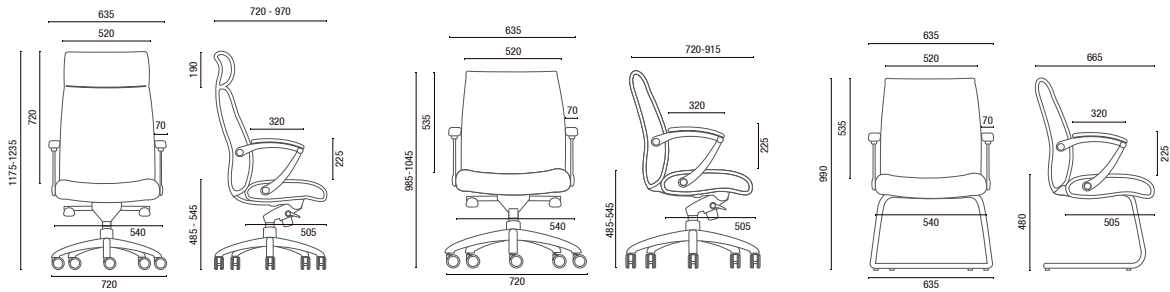

20201
Presidente Giratória

20202
Diretor Giratória

20206
Diretor Aproximação

PRIME 20100

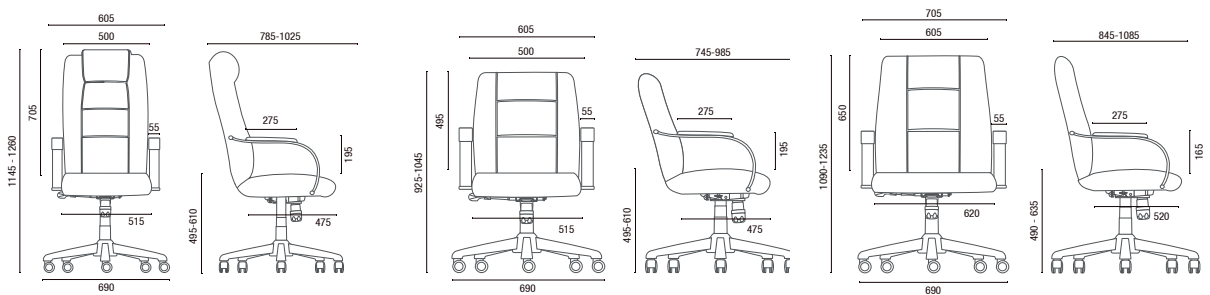

20101
Presidente Giratória

20102
Diretor Giratória

20103
Diretor Giratória Extra

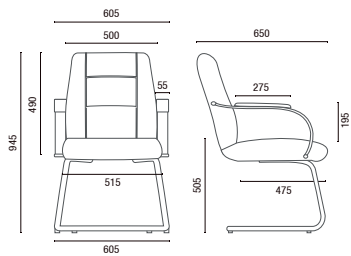

20106 S
Diretor Aproximação

MASTER 20000

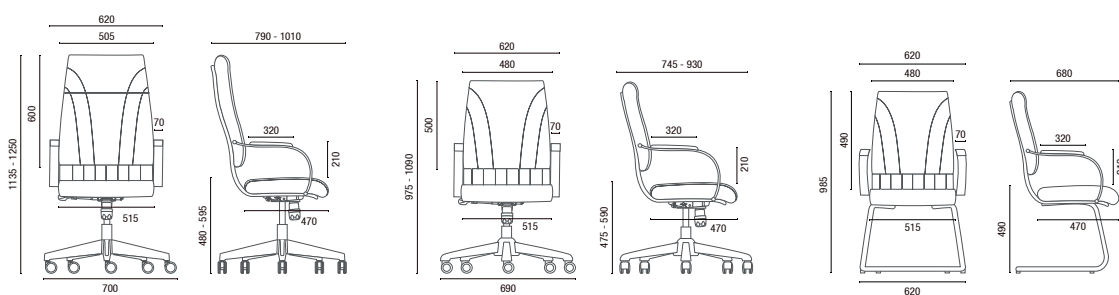

20001
Presidente Giratória

20002
Diretor Giratória

20006 S
Diretor Aproximação

OBS: Medidas extremas obtidas sem o uso de gabarito de carga.



Cavaletti S/A Cadeiras Profissionais
Rua Dr. Hiram Sampaio, 550
Erechim/RS Brasil 99.706-461
Fone/Fax: (54) 3520.4100
atendimento@cavaletti.com.br
www.cavaletti.com.br



A close-up photograph of a white leather office chair. The focus is on the armrest, which is made of a polished chrome material. The leather has a subtle, cracked texture and is stitched with white thread. The background is a plain, light color.

Cavaletti®

CADEIRAS PROFISSIONAIS

Cavaletti Chroma

Cavaletti Chroma

A linha Chroma apresenta beleza do couro 100% natural associada à leveza dos cromados por meio de um design clássico e atemporal.



REVESTIMENTOS

Revestimento em Couro 100% Natural com quatro opções de cores.



MECANISMOS

Mecanismo Relax com sistema de travamento na posição de trabalho ou livre flutuação, com regulagem de tensão por manípulo frontal.

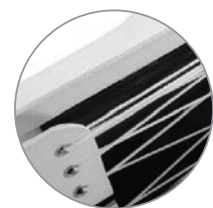

ASSENTO

Assento com proteção na parte inferior, evitando que o couro fique marcado. Regulagem de Altura à gás.



BRAÇOS

Braços integrados à estrutura, que proporcionam maior solidez construtiva e durabilidade.



BASES

Opções de Bases Estampada ou Eliptica (acabamento cromado), com rodízios de 50mm em Nylon ou PU. Base em Alumínio com rodízios 65mm em Nylon ou PU.



ESTRUTURA

Estrutura fixa Balanço (S) com acabamento Cromado.

CONFIGURAÇÕES



14001
Presidente Giratória
Relax
Braços Integrados
Base Eliptica



14001
Presidente Giratória
Relax
Braços Integrados
Base Estampada



14004
Secretária Giratória
Mecanismo Fixo sem Relax
Braços Integrados
Base Eliptica



14007 S
Secretária Aproximação
Estrutura S
Braços Integrados

CORES

A linha Chroma oferece revestimento em Couro 100% Natural com quatro opções de cores: Marrom, Bege, Preto e Branco.



958
Marrom



977
Bege

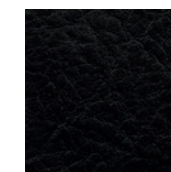

991
Preto

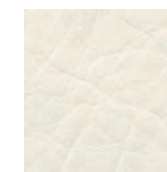

995
Branco

DESENHOS TÉCNICOS

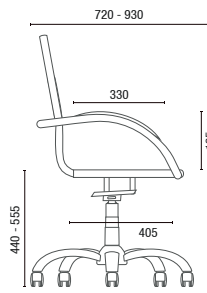
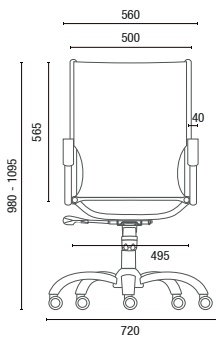

14001 **Presidente Giratória Aranha Elíptica**

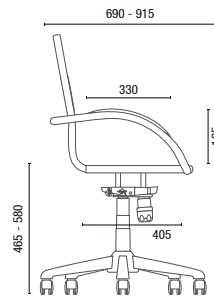
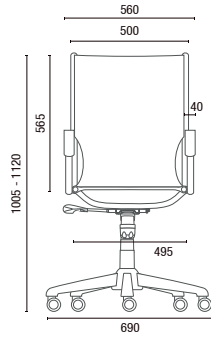

14001 **Presidente Giratória Aranha Estampada**

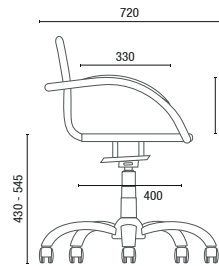
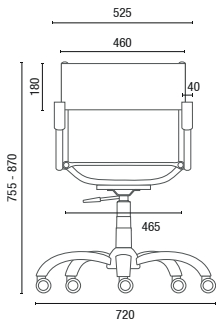

14004 **Secretária Giratória Aranha Elíptica**

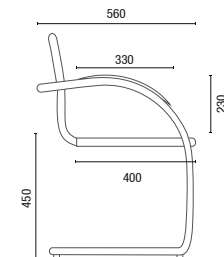
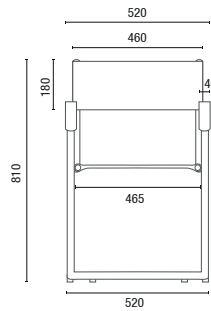

14007 S **Secretária Aproximação**

OBS: Medidas extremas obtidas sem o uso de gabarito de carga.



Cavaletti S/A Cadeiras Profissionais
Rua Dr. Hiram Sampaio, 550
Erechim/RS Brasil 99.706-461
Fone/Fax: (54) 3520.4100
atendimento@cavaletti.com.br
www.cavaletti.com.br





Cavaletti[®]

CADEIRAS PROFISSIONAIS

Cavaletti Joy

Cavaletti Joy

Leve. Simples. Descomplicada.

A Cavaletti Joy oferece a simplicidade de um desenho sem excessos, combinada com a praticidade de uma paleta de cores exclusiva. Compacta e funcional, é um jeito inteligente de tornar todo tipo de ambiente coletivo mais atraente e despojado.



CARACTERÍSTICAS

Tem horas que tudo o que a gente precisa é descomplicar.



HANDLE
Design inteligente, permite praticidade no manuseio.



CLICKS
Sem parafusos. O sistema de montagem é todo por click.



PROTEÇÃO
Apoio para empilhamento com esperas em TPE.



EMPILHAMENTO
Empilhável até 10 unidades.

COMPOSIÇÕES



41.008
Branco Off
Plásticos Branco Off 44
Base Branco Ultrafosco
Opção de Base Cromada



41.008
Cinza
Plásticos Cinza 41
Base Prata
Opção de Base Cromada



41.008
Grafite
Plásticos Grafite 45
Base Grafite Ultrafosco
Opção de Base Cromada



41.008
Preto
Plásticos Preto 06
Base Preto Universal
Opção de Base Cromada



41.008
Azul
Plásticos Azul Noite 32
Base Azul Ultrafosco
Opção de Base Cromada



41.008
Oliva
Plásticos Oliva 76
Base Oliva Ultrafosco
Opção de Base Cromada



41.008
Areia
Plásticos Areia 77
Base Areia Ultrafosco
Opção de Base Cromada



41.008
Telha
Plásticos Telha 78
Base Telha Ultrafosco
Opção de Base Cromada



41.008
Amarelo
Plásticos Amarelo 16
Base Amarelo Ultrafosco
Opção de Base Cromada



41.008
Vermelho
Plásticos Vermelho Apple 43
Base Vermelho Ultrafosco
Opção de Base Cromada



Carrinho
Empilhamento máximo: 10 unidades

DESENHOS TÉCNICOS

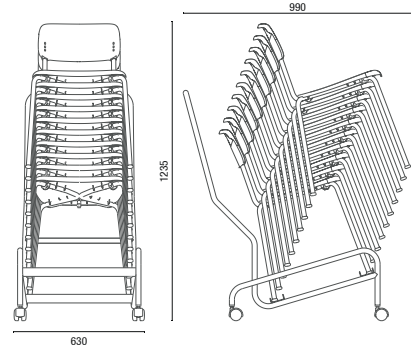
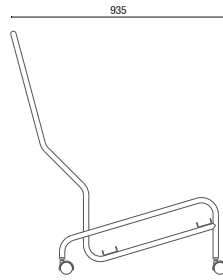
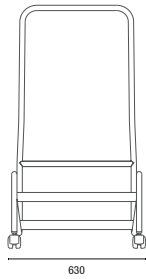
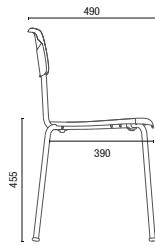
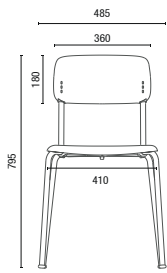

41.008 Aproximação

Carrinho Joy

Carrinho Joy
Empilhamento máximo: 10 unidades

OBS: Medidas extremas obtidas sem o uso de gabarito de carga.

ESTRUTURAS

	Preto (101) Universal	Prata (13) Semifosco	Cromado (05)	Grafite (80) Ultrafosco	Vermelho (85) Ultrafosco	Telha (84) Ultrafosco	Amarelo (86) Ultrafosco	Areia (83) Ultrafosco	Oliva (82) Ultrafosco	Azul (81) Ultrafosco	Branco (79) Ultrafosco	Rosa Suave (100) Ultrafosco
Preto 06	●	●	●									
Grafite 45	●	●	●	●								
Vermelho Apple 43	●	●	●		●							
Telha 78	●	●	●			●						
Amarelo 16	●	●	●				●					
Areia 77	●	●	●					●				●
Oliva 76	●	●	●						●			
Azul Noite 32	●	●	●							●		
Cinza 41	●	●	●									
Branco Off 44	●	●	●								●	

PLÁSTICOS



Cavaletti S/A Cadeiras Profissionais
Rua Dr. Hiram Sampaio, 550
Erechim/RS Brasil 99.706-461
Fone/Fax: (54) 3520.4100
atendimento@cavaletti.com.br
www.cavaletti.com.br



Cavaletti

CADEIRAS PROFISSIONAIS



Cavaletti Go

Cavaletti Go

A linha Go nasceu para oferecer flexibilidade – estética e funcional – para ambientes contemporâneos. Assim, o conceito original se desdobra em múltiplas configurações para atender necessidades de cada utilização – seja uma sala de reuniões, um café, um espaço de espera ou mesmo um home office.

O resultado é um design puro, de linhas precisas e icônicas, que pode ser complementado com acessórios para níveis progressivos de conforto conforme o tempo de uso. Os complementos permitem modificar a estética do produto e adequá-lo à identidade de cada espaço.



product
design award

2013



CARACTERÍSTICAS

BRAÇOS VERSÁTEIS

Integrados ao design do produto, permitindo empilhamento.



PROTEÇÃO PARA EMPILHAMENTO

Contra-assento injetado para proteção durante o empilhamento.



ESTOFAMENTO INTELIGENTE

Permite adição de estofamento de forma independente no assento e no encosto, aumentando o nível de conforto de forma progressiva. Disponível em duas opções de espessura: 7mm ou 25mm.



CAPACIDADE DE EMPILHAMENTO

Empilhamento de até 15 cadeiras (no carrinho para transporte).
Empilhamento de até 6 cadeiras (fora do carrinho).



*Carrinho para transporte opcional.

CORES E ACABAMENTOS

COSTURAS



Lisa Losango Aleatória Bordado Personalizado

PLÁSTICOS



06 Preto 45 Grafite 41 Cinza 44 Branco Off 42 Azul Marine 40 Verde Lima 43 Vermelho Apple 33 Laranja 60 Amarelo

ESTRUTURAS



Cromado (05) Preto (101) Universal Prata (13) Semifosco Cinza (12) Brilhante Grafite (80) Ultrafosco Branco (79) Ultrafosco Vermelho (85) Ultrafosco Telha (84) Ultrafosco Amarelo (86) Ultrafosco Areia (83) Ultrafosco Oliva (82) Ultrafosco Azul (81) Ultrafosco Rosa Suave (100) Ultrafosco

CONFIGURAÇÕES

GO BASIC

Braços Opcionais

GO SOFT

Braços Opcionais
Assento Estofado

GO COMPLETE

Braços Opcionais
Assento e Encosto Estofados

34003
Giratória



34006
Aproximação



34020
Banqueta Alta



MODELOS ESPECIAIS

Modelos Especiais disponíveis nas versões Basic, Soft e Complete.



34006 P
Aproximação
Pés Palito
Braços Opcionais



34006 P ROD
Aproximação
Pés Palito com Rodízios
Braços Opcionais



34006
Prancheta
Opções Fixa (U), Removível (UR)
e Escamoteável (UE)



34010
Longarina
Braços Opcionais
Sapata traseira com regulagem
Disponível com 2, 3, 4 ou 5 lugares

DESENHOS TÉCNICOS

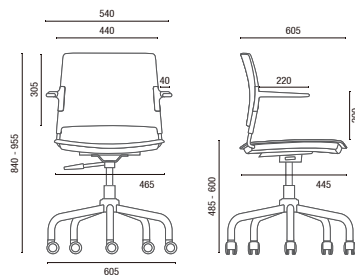

34003 Giratória

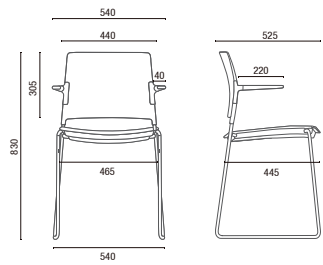

34006 Aproximação

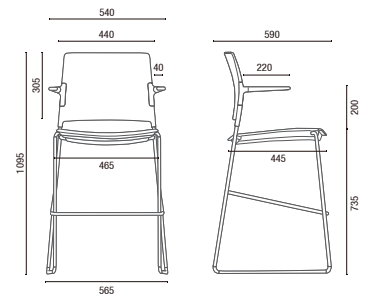

34020 Banqueta Alta

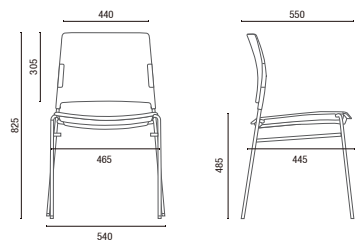

34006 P Aproximação

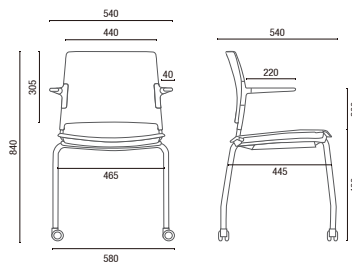

34006 P ROD Aproximação Giratória

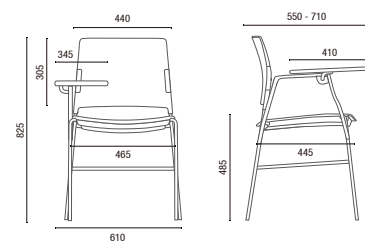

34006 U Prancheta Escamoteável

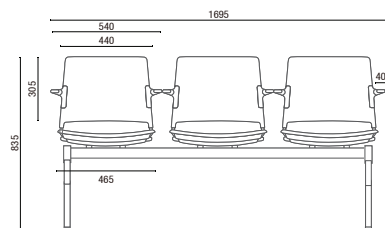

34010 Longarina

Larguras com Braço:
 2L - 1110mm
 3L - 1695mm
 4L - 2270mm
 5L - 2860mm

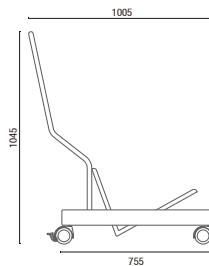
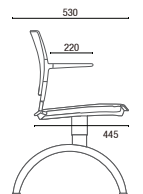

Carrinho

Empilhamento máximo: 15 unidades

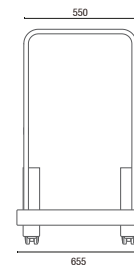

OBS: Medidas extremas obtidas sem o uso de gabarito de carga.



Cavaletti S/A Cadeiras Profissionais
 Rua Dr. Hiram Sampaio, 550
 Erechim/RS Brasil 99.706-461
 Fone/Fax: (54) 3520.4100
 atendimento@cavaletti.com.br
 www.cavaletti.com.br



Cavaletti

CADEIRAS PROFISSIONAIS



Cavaletti Stay

Cavaletti Stay

A relação das pessoas com o tempo mudou...

A conectividade transformou a forma
como vivemos, trabalhamos, relaxamos.

Hoje, todo lugar pode ser um ambiente produtivo:
uma sala de espera, um café, uma biblioteca.

E esta mudança pede cadeiras adequadas
a este novo comportamento.

A linha Stay oferece o conforto ideal para todos
os momentos.



PRODUTIVIDADE Stay

“in between” conectividade

NO PROBLEMS

cadeiras praticidade & LEITURA

NOVAS IDEIAS

LIGHT Cavaletti

NEW CORES TEMPO interação

ambientes criativos

COMFORTO & DIVERSÃO



ATIVIDADE Stay
 "conectividade
 PROBLEMS
 LEITURA
 IDEIAS
 Cavaletti
 TEMPO interação
 conforto &
 Diversão
 mentes criativos



CONFIGURAÇÕES



33106 P
 Aproximação Empilhável
 Estrutura Palito
 Braços Integrados
 Empilhamento máximo: 04 unidades



33107 A
 Aproximação
 Estrutura Arco
 Braços Integrados



33108
 Giratória
 Braços Integrados



33104
 Giratória
 Braços Integrados



33206
 Aproximação
 Pés de Madeira Envernizados



33120
 Banqueta Alta
 Estrutura Palito
 Braços Integrados



33110
 Longarina
 Braços integrados

ESTRUTURAS

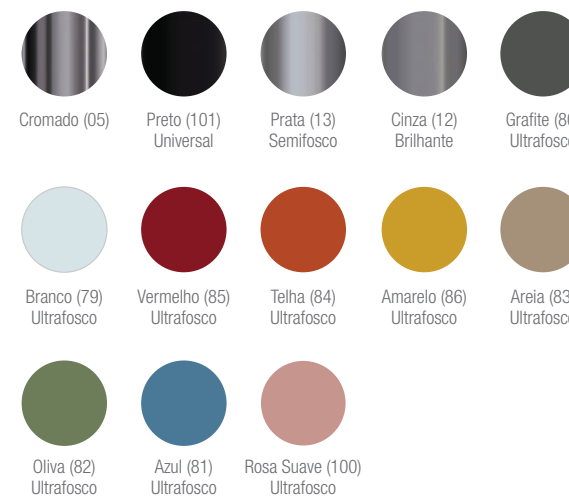

CORES

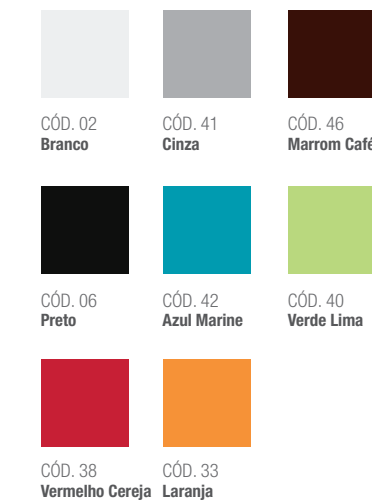

DESENHOS TÉCNICOS

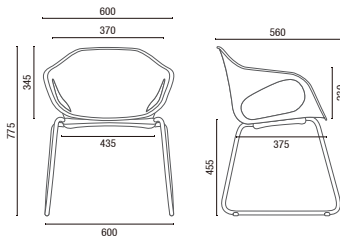

33107 A Aproximação

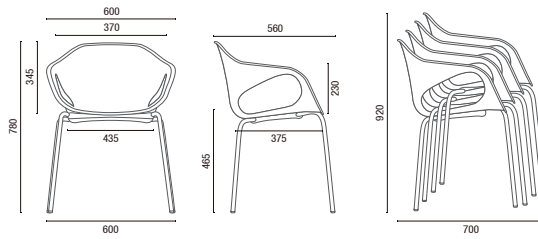

33106 P Aproximação Empilhável
Empilhamento máximo: 04 unidades

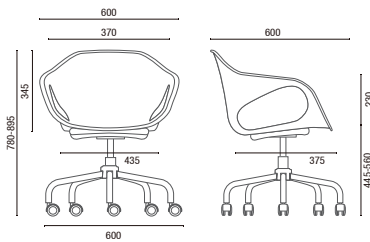

33104 Giratória

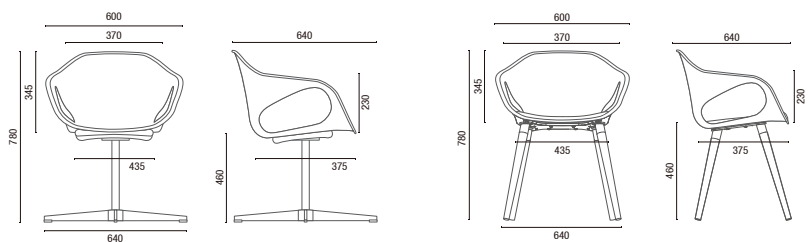

33108 Giratória

33206 Aproximação

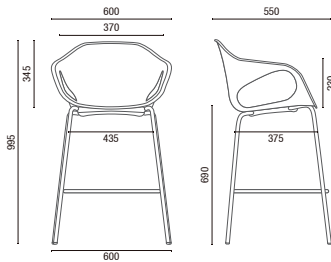

33120 Banqueta Alta

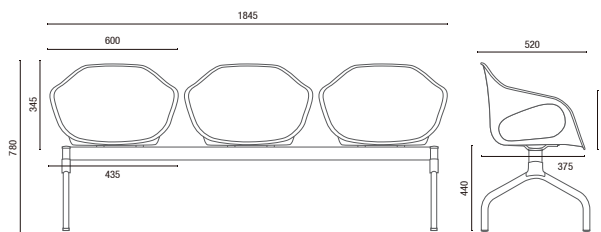

33110 Longarina

Larguras:
2L – 1230mm
3L – 1845mm
4L – 2470mm
5L – 3090mm

OBS: Medidas extremas obtidas sem o uso de gabarito de carga.



Cavaletti S/A Cadeiras Profissionais
Rua Dr. Hiram Sampaio, 550
Erechim/RS Brasil 99.706-461
Fone/Fax: (54) 3520.4100
atendimento@cavaletti.com.br
www.cavaletti.com.br



Cavaletti

CADEIRAS PROFISSIONAIS

®



Cavaletti Viva

Cavaletti Viva

Inspirada na natureza, a linha Viva traz tonalidades exclusivas para serem combinadas com diversas configurações, adaptando-se a qualquer ambiente. Além da variedade de cores, os produtos apresentam design Cavaletti, exclusivo e mais ergonômico.

Aproveite, imagine, crie. Viva!

Ambientes de aprendizagem projetados para inspirar. A cadeira Viva com prancheta 360° possibilita fácil acesso e mobilidade, pois permite ser utilizada no lado esquerdo ou direito, na posição longitudinal, horizontal ou inclinada. Ideal para reajustes de layout, visando promover a interação entre participantes em atividades de aprendizado de maneira ativa e em grupo, com paleta de cores exclusivas para personificar os ambientes coletivos.



VERSÕES

VIVA

Os modelos da linha Viva possuem o Pega-Mão, que facilita o seu manuseio e transporte. Disponível em quinze tonalidades diferentes.

VIVA SPM

A versão Viva SPM traz a cadeira Viva sem o Pega-Mão em quatro opções de cores: Azul, Vermelho, Branco e Preto. Disponível para todas as configurações.



Design
original
Cavaletti

35004 Prancheta 360°

CORES

VIVA



27 Verde Limão 28 Verde 30 Azul Marinho 34 Azul 31 Vermelho



33 Laranja 16 Amarelo 02 Branco 12 Cinza 06 Preto

VIVA SPM



34 Azul 31 Vermelho 02 Branco 06 Preto

Disponível em cor personalizada para pedidos a partir de 500 unidades.

ESTRUTURAS



101 Preto Universal 13 Prata Semifosco 05 Cromado 80 Grafite Ultrafosco 79 Branco Ultrafosco



85 Vermelho Ultrafosco 84 Telha Ultrafosco 86 Amarelo Ultrafosco 83 Areia Ultrafosco 82 Oliva Ultrafosco 81 Azul Ultrafosco

Acabamentos, ponteiros e o centro da longarina sempre serão na cor preta.

CONFIGURAÇÕES



35008 P
Aproximação Empilhável
Estrutura Palito



35008 P
Aproximação Empilhável
Empilhamento máximo:
10 unidades



35007 P
Aproximação
Estrutura Palito



35007 SE
Aproximação
Estrutura Balanço
Assento Estofado
Disponível com Assento
Plástico sem Estofamento



35008 A
Aproximação Empilhável
Estrutura Arco
Empilhamento máximo:
05 unidades



35004
Giratória
Braço Z
Base Viva
Mecanismo Flange



35004 SL
Giratória
Braço SL
Base de Aço com Capa
Mecanismo Flange



35004
Giratória
Prancheta 360°
Base Viva
Mecanismo Flange



35007 Z
Aproximação
Braços Integrados



35007 Z ROD
Aproximação com Rodízios
Braços Integrados



35010
Longarina



35008 PU
Universitária
Estrutura Palito com Grade
Prancheta Removível



Mecanismo de União
Modelos 35007 Z



Estofamento
Opção de assento e/ou encosto
estofados. Disponível para todos
os modelos.



35008 PUE
Universitária
Prancheta Escamoteável

DESENHOS TÉCNICOS

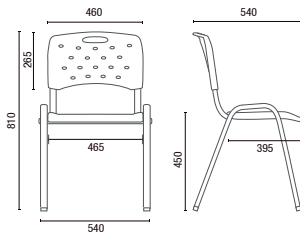

35008 P Aproximação Empilhável

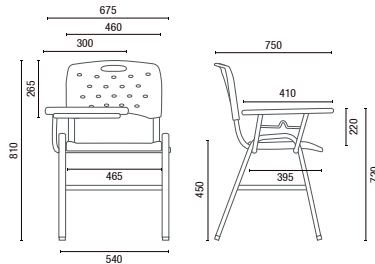

35008 PU Universitária

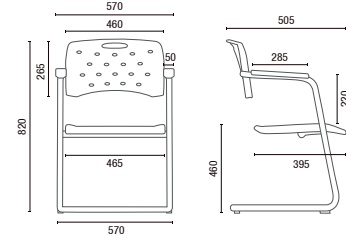

35007 S Aproximação

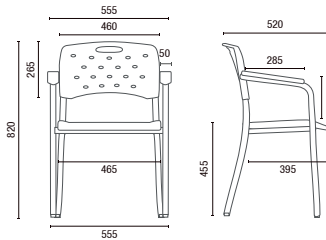

35007 P Aproximação

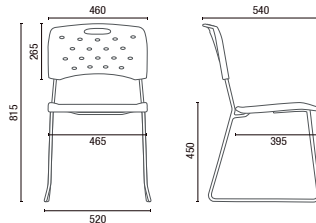

35008 A Aproximação Empilhável

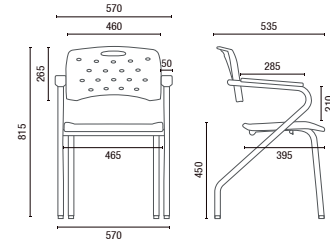

35007 Z Aproximação

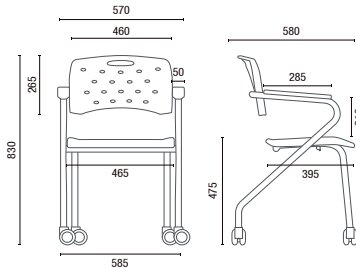

35007 Z ROD Aproximação com Rodízios

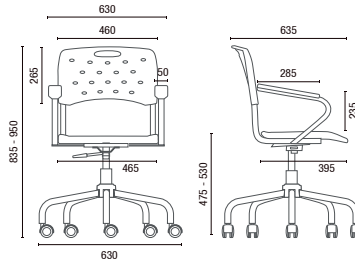

35004 Giratória Base Viva

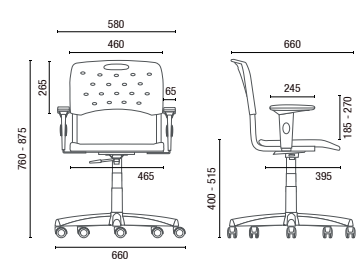

35004 Giratória Base em Aço com Capa

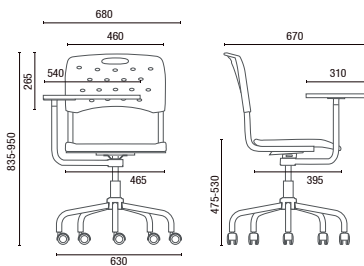

35004 Giratória Prancheta 360°

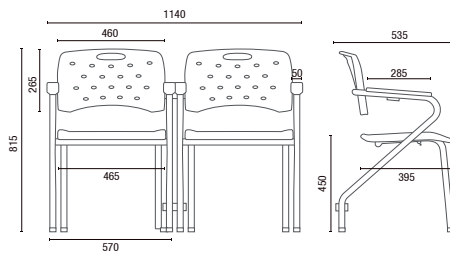

35007 Z Aproximação com Mecanismo de União

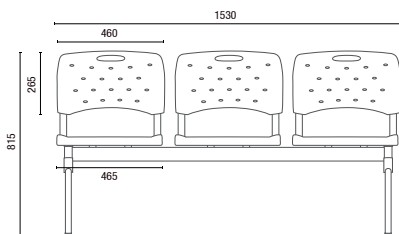

35010 Longarina

Larguras sem Braço:

2L - 1025mm 3L - 1530mm 4L - 2050mm 5L - 2575mm



OBS: Medidas extremas obtidas sem o uso de gabarito de carga.



Cavaletti S/A Cadeiras Profissionais
Rua Dr. Hiram Sampaio, 550
Erechim/RS Brasil 99.706-461
Fone/Fax: (54) 3520.4100
atendimento@cavaletti.com.br
www.cavaletti.com.br



*Produtos Certificados com Rótulo Ecológico (Qualidade - ABNT - Ambiental), sob consulta ao Departamento Comercial - Setor Público.

Cavaletti

CADEIRAS PROFISSIONAIS



Cavaletti Solo



Cavaletti Solo

Em momentos individuais de conexão, contemplação e desconpressão, o design contemporâneo da Cavaletti Solo convida para uma experiência de conforto entre as atividades do dia.

OBS.: Produtos nesta imagem em Liv Arenito 500 e Basalto 513. Produtos da capa em Couro Natural Caramelo 259.

CARACTERÍSTICAS

A reinvenção da pausa

Com encosto alto e formas acolhedoras, a Cavaletti Solo estimula a mudança de postura e torna as pausas muito mais inspiradoras, especialmente quando combinada ao Ottoman.



OBS.: Produtos nesta imagem em Haven Areia 560 e Couro Natural Caramelo 259.

Um produto, vários moods

Disponíveis nas versões giratória ou fixa, as bases da Cavaletti Solo apresentam 12 opções de cores, que combinadas com mais de 80 revestimentos, se adaptam a diferentes estilos de ambiente.



OBS.: Produtos nesta imagem em Grid Bege Marfim 360, Haven Campo 556 e Savana 557.

CONFIGURAÇÕES



OBS.: Nestas imagens, Solo e Ottoman em Politex Cinza Metal 402 e Mesas Laterais com tampo em MDF Elmo Suíço.

DETALHES



REVESTIMENTOS

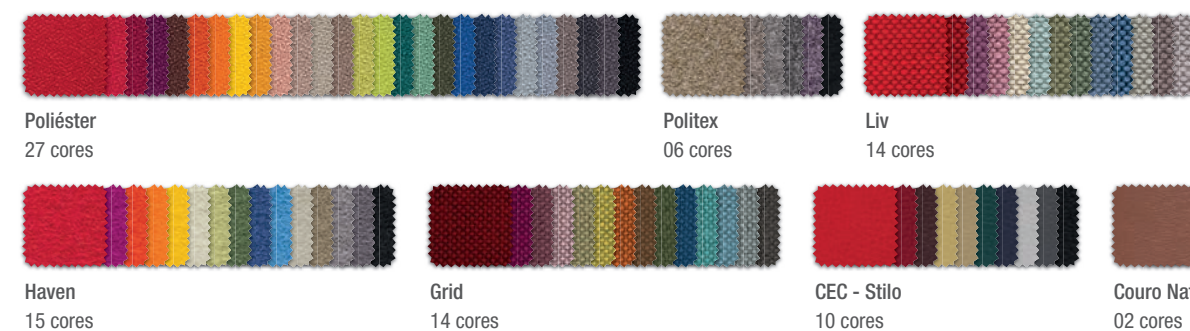

ESTRUTURAS

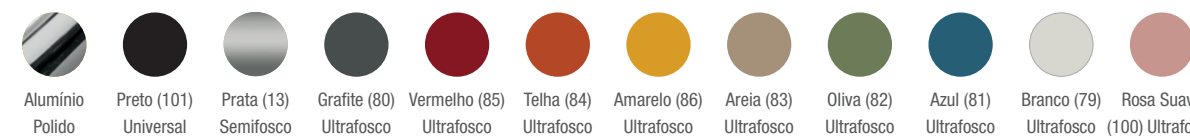

OBS.: Cores disponíveis para ambos os tipos de Bases, exceto o Alumínio Polido, disponível apenas para Base Giratória.

DESENHOS TÉCNICOS

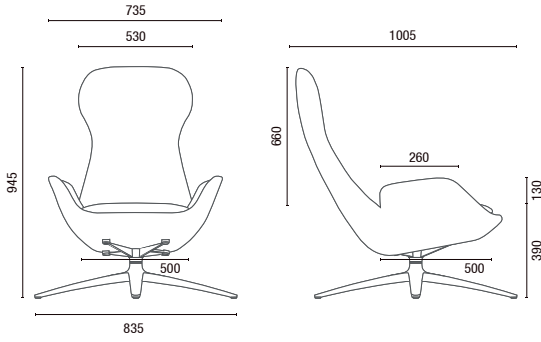

36.101 Poltrona Giratória - Base em Alumínio Polido

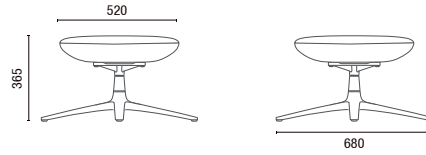

36.102 Ottoman Giratório - Base em Alumínio Polido

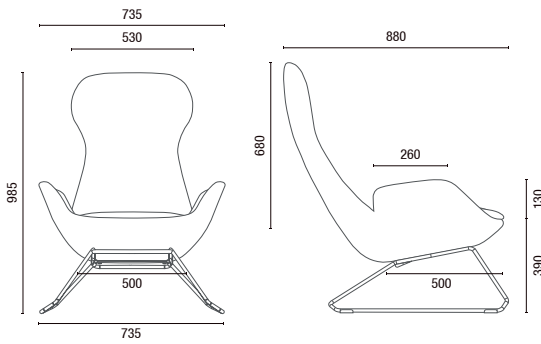

36.111 Poltrona Fixa - Base Frame

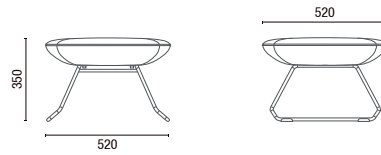

36.112 Ottoman Fixo - Base Frame

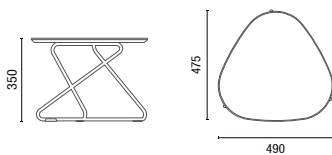

36.113 Mesa Lateral - Base Frame

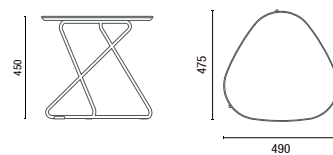

36.114 Mesa Lateral - Base Frame

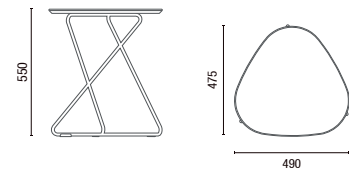

36.115 Mesa Lateral - Base Frame

OBS: Medidas extremas obtidas sem o uso de gabarito de carga. Para especificação de cores e acabamentos, utilizar sempre amostras físicas originais Cavaletti.



Cavaletti S/A Cadeiras Profissionais
Rua Dr. Hiram Sampaio, 550
Erechim/RS Brasil 99.706-461
Fone/Fax: (54) 3520.4100
atendimento@cavaletti.com.br
www.cavaletti.com.br



Cavaletti

CADEIRAS PROFISSIONAIS



Cavaletti Duo

Cavaletti Duo

Cavaletti Duo é assim: um item perfeito para compor os mais diversos espaços, com a possibilidade de configurar acabamentos que fazem toda a diferença. Para quem usa, uma cadeira versátil, com linhas simples e ao mesmo tempo marcantes. Para quem pensa na concepção do ambiente, uma infinidade de combinações.



CARACTERÍSTICAS

Minimalista, exceto nas opções.

São diferentes opções de bases fixas ou giratórias, capazes de se adaptar perfeitamente ao uso e estilo que você imagina. Você pode configurar a concha de cor única ou bicolor, ou com madeira e revestimento à sua escolha.



OBS: Produtos nesta imagem em CEC - Stilo Fendi 194; Couro Caramelo 259; Haven Terracota 552; Haven Campo 556 e Haven Concreto 562; Liv Jade 511.

Customizável

Na Cavaletti Duo, além de configurar os revestimentos e concha, nas bases tipo disco e 4 hastas ainda é possível customizar as cores da estrutura, conforme tabela neste catálogo.



OBS: Produtos nesta imagem em Haven Céu 559 e estrutura Azul; Liv Jade 511 e estrutura Preto Universal; Haven Laranja 553 e estrutura Telha; Liv Calcário 515 e estrutura Branco Ultrafosco.

CONFIGURAÇÕES



36.071
Poltrona Reunião
Giratória
Base Twin com Rodízios
Opção de altura fixa
Opção de Relax



36.072
Poltrona Reunião
Giratória
Base Twin com Sapatas
Opção de altura fixa
Opção de Relax



36.172
Poltrona Interlocutor
Giratória
Base 4 hastas



36.074
Poltrona Interlocutor
Giratória
Base Piramidal



36.174
Poltrona Interlocutor
Base Pé Palito



36.272
Poltrona Interlocutor
Giratória
Base Disco



36.075 3L
Longarina 3 Lugares



36.075 2L
Longarina 2 Lugares



36.075
Banco



Concha Bicolor
Aplicação de 02 cores
de um mesmo revestimento

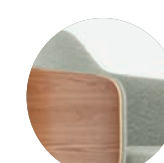

Concha de Madeira
Aplicação de concha de
madeira e revestimento

OBS: Produtos nestas imagens em Politex Cinza Metal 402 e na Capa deste catálogo em Politex Café com Leite 403 e estrutura Areia; Haven Areia 560; Haven Terracota 552, Couro Caramelo 259; Liv Calcário 515.

REVESTIMENTOS



Haven
15 cores

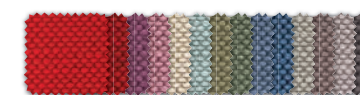

Liv
14 cores



Couro Natural
02 cores



CEC - Stilo
10 cores

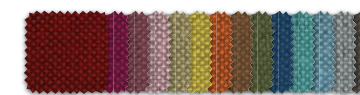

Grid
14 cores



Politex
06 cores

ESTRUTURAS

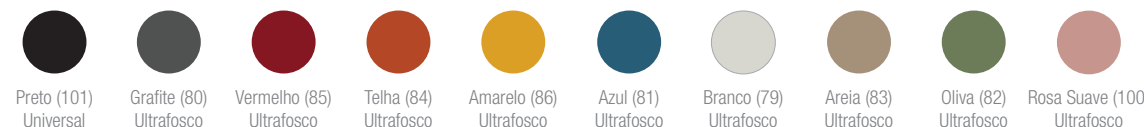

DESENHOS TÉCNICOS

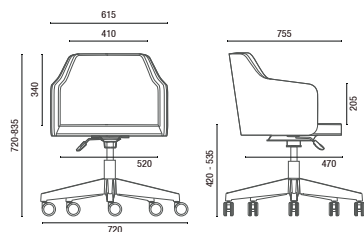

36.071 Poltrona Reunião
Giratória
Base Twin com Rodízios
Opção de Relax

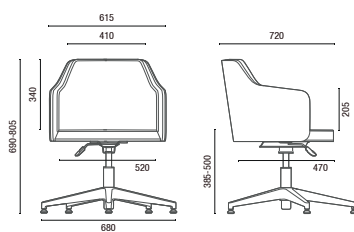

36.072 Poltrona Reunião
Giratória
Base Twin com Sapatas
Opção de Relax

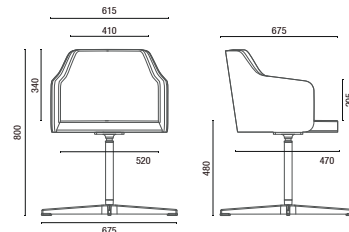

36.172 Poltrona Interlocutor
Giratória
Base 4 hastes

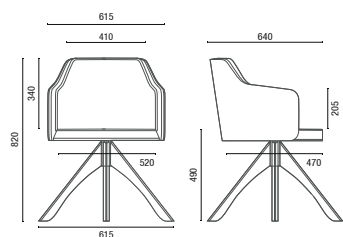

36.074 Poltrona Interlocutor
Giratória
Base Piramidal

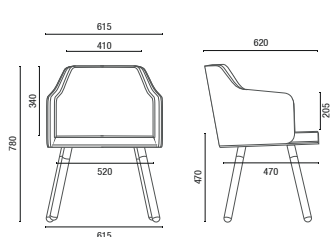

36.174 Poltrona Interlocutor
Base Pé Palito

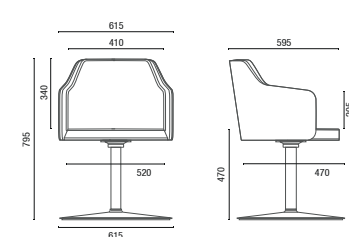

36.272 Poltrona Interlocutor
Giratória
Base Disco

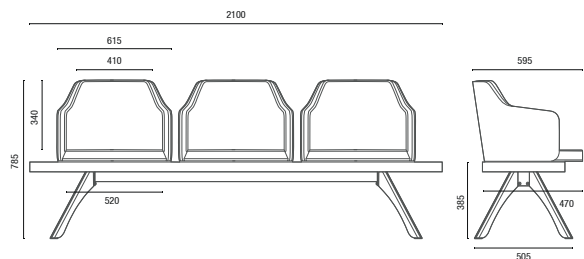

36.075 3L Longarina 3 Lugares

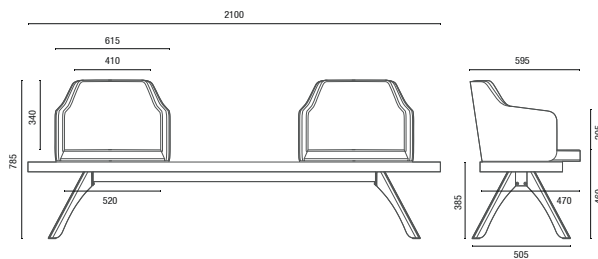

36.075 2L Longarina 2 Lugares

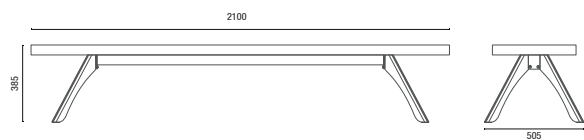

36.075 Banco

OBS: Medidas extremas obtidas sem o uso de gabarito de carga.



Cavaletti S/A Cadeiras Profissionais
Rua Dr. Hiram Sampaio, 550
Erechim/RS Brasil 99.706-461
Fone/Fax: (54) 3520.4100
atendimento@cavaletti.com.br
www.cavaletti.com.br



Cavaletti®

CADEIRAS PROFISSIONAIS



Cavaletti Stretch



Cavaletti Stretch

Cavaletti Stretch é um produto com design autoral, pensado para transformar momentos de desconpressão em inspiração, com a união de materiais como aço, madeira e revestimentos nobres na mesma peça. A cadeira, de assento mais baixo, proporciona uma mudança de postura saudável ao longo do dia. Seu uso pode ser combinado a acessórios como mesa lateral e apoio para os pés, compondo ambientes com muito estilo e ergonomia.

OBS: Produtos nesta imagem com revestimento em Haven Savana 557, Céu 559 e Terracota 552.

CARACTERÍSTICAS

Conforto que Inspira

A poltrona, de assento mais baixo e generoso, é um convite para a mudança de postura nos momentos de pausa e desconpressão, recuperando as energias e aumentando a produtividade.



OBS: Produtos nesta imagem com revestimento em Haven Crepúsculo 558 e Laranja 553.



Customizável

São 10 opções de cores para a estrutura e mais de 50 opções de cores de revestimentos (Liv, Haven, Grid, CEC - Stilo e Couro Natural).

Resistência e Durabilidade

Estrutura da poltrona e dos acessórios construída 100% em aço e com solda, eliminando a necessidade de parafusos.

OBS: Produtos nesta imagem com revestimento em Haven Céu 559, Vermelho 550, Savana 557 e Laranja 553.

COMPOSIÇÕES



Bases

Você escolhe a base da cadeira de acordo com a personalidade do ambiente. Modelo Fixo com apoio de pés para uso estático e Esqui para uso dinâmico em ambientes mais informais.



36.906
Poltrona
Base 4 pés com ponteiros em madeira natural



36.906
Poltrona Esqui
Base esqui em madeira laminada de Tauari envernizado.

Acessórios

A mesa lateral pode ser utilizada como apoio ou para acomodar objetos de decoração. Já o Ottoman, é um convite para esticar as pernas, deixando o ambiente ainda mais acolhedor, sendo seu uso recomendado com a Poltrona de Base Fixa.



36.914
Ottoman
Apoio para os pés
Ponteiros em madeira natural



36.901
Mesa lateral
Tampo em Tauari envernizado
Ponteiros em madeira natural

OBS: Produtos nestas imagens com revestimentos em Couro Natural Caramelo 259 e na capa deste catálogo em Haven Céu 559. As cores e revestimentos expostos neste catálogo são ilustrativos, e devem ser utilizados somente como referência. Para maiores informações, consulte mostruário.

DESENHOS TÉCNICOS

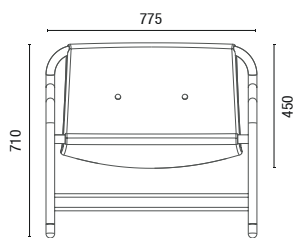

36.906 Poltrona Base Fixa

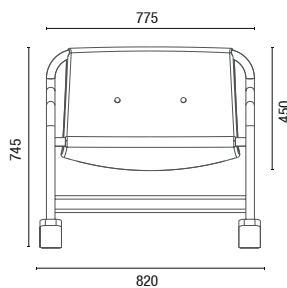
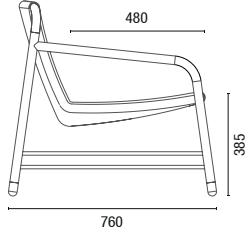

36.906 Poltrona Base Esqui

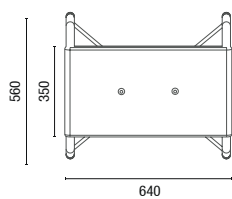
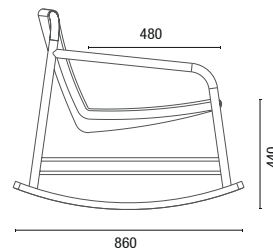

36.914 Ottoman

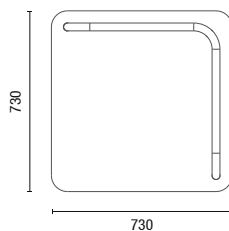
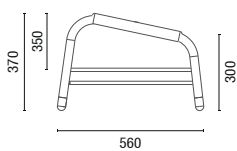

36.901 Mesa de Apoio

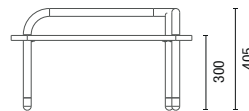

OBS: Medidas extremas obtidas sem o uso de gabarito de carga.

ESTRUTURAS



Preto (101)
Universal



Grafite (80)
Ultrafosco



Vermelho (85)
Ultrafosco



Telha (84)
Ultrafosco



Amarelo (86)
Ultrafosco



Areia (83)
Ultrafosco



Oliva (82)
Ultrafosco



Azul (81)
Ultrafosco



Branco (79)
Ultrafosco



Rosa Suave (100)
Ultrafosco

REVESTIMENTOS

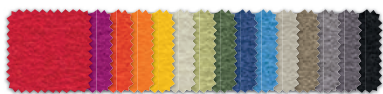

Haven
15 cores

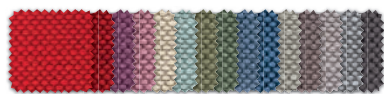

Liv
15 cores



Couro Natural
02 cores



CEC - Stilo
10 cores

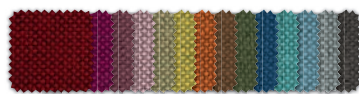

Grid
14 cores



Cavaletti S/A Cadeiras Profissionais
Rua Dr. Hiram Sampaio, 550
Erechim/RS Brasil 99.706-461
Fone/Fax: (54) 3520.4100
atendimento@cavaletti.com.br
www.cavaletti.com.br



Cavaletti®

CADEIRAS PROFISSIONAIS



Cavaletti Fun



Cavaletti Fun

A linha Fun é direcionada a ambientes informais, nos quais um mobiliário leve e de linhas básicas ajuda a compor espaços agradáveis para o convívio e descontração. São modelos variados, todos disponíveis em cores para criar uma atmosfera alegre ou relaxante.



14020
Banqueta
Assento em Madeira com Verniz



14020
Banqueta
Assento Estofado

Produtos nessa imagem: Banqueta em madeira envernizada com estrutura Telha (84) e Banqueta estofada em CEC - Stilo Verde (315) com estrutura Oliva (82).

ESTRUTURAS

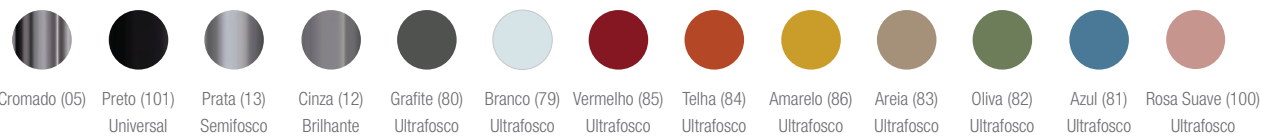

Produtos na imagem de ambientação: Banquetas em madeira envernizada com estrutura Telha (84) e CEC - Stilo Verde (315) com estrutura Oliva (82). Puffs em Liv Jaspe (507), Liv Quartzo Rosa (509), Liv Arenito (500), Liv Turquesa (502), Liv Petróleo (505), Liv Carbono (504), Haven Vermelho (550), Haven Céu (559), Haven Neve (555), Haven Laranja (553), Haven Terra (561) e Haven Asfalto (563). Spin em Haven Concreto (562). Stretch em CEC - Stilo Azul (314) com estrutura Azul (81). Mesa Spin 36803 estrutura Areia (83).

CONFIGURAÇÕES



14015
Banqueta Alta
Com escosto
*Opcional com 50cm



14015
Banqueta Alta
*Opcional com 50cm



PUFF
Hexagonal Irregular
36.350 - Baixo 350mm
36.445 - Médio 450mm
36.475 - Alto 750mm



14016
Banqueta
Com escosto



14016
Banqueta
Sem escosto



PUFF
Hexagonal Regular
36.635 - Baixo 350mm
36.645 - Médio 450mm
36.675 - Alto 750mm



36016
Banco Giratório
Base em Alumínio



746
Revisteiro



747
Revisteiro



PUFF
Quadrado
36.030 - 450mm

Produtos nessa página: Banquetas em CEC - Stilo Azul (314) com estrutura Azul (81), CEC - Stilo Verde (315) com estrutura Branco (79), CEC - Stilo Fendi (194) com estrutura Areia (83), CEC - Stilo Cinza (175) com estrutura Preto Universal (101) e CEC - Stilo Vinho (233) com base em Alumínio. Revisteiros em Vermelho (85) e Cinza (12). Puffs em Haven Areia (560), Haven Savana (557), Haven Terra (561), Liv Niquel (514), Liv Quartzo Rosa (509), Liv Turquesa (502) e Liv Safira (512).

DESENHOS TÉCNICOS

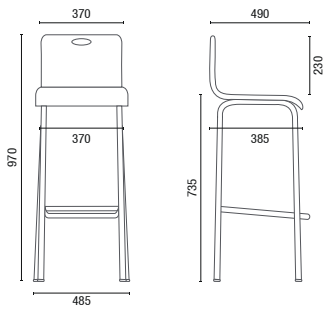

14020 Banqueta em Madeira

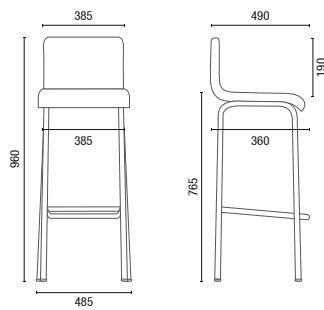

14020 Banqueta em Estofado

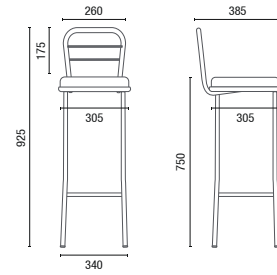

14015 Banqueta Alta com Encosto

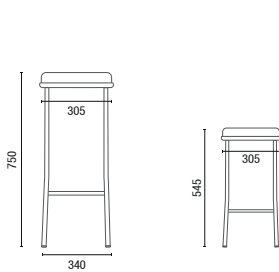

14015 Banqueta Alta/Baixa

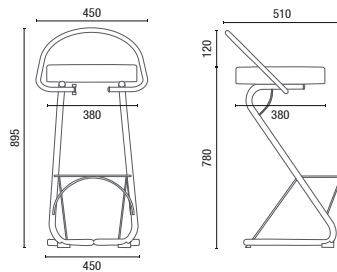

14016 Banqueta com Encosto

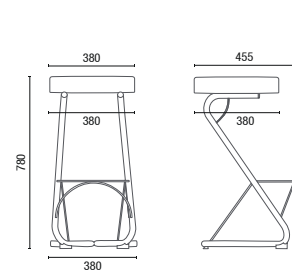

14016 Banqueta

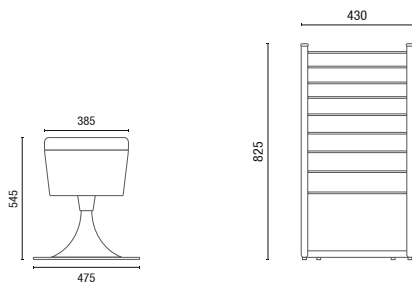

36016 Banco Giratório



746 Revisteiro

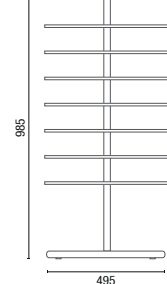

747 Revisteiro

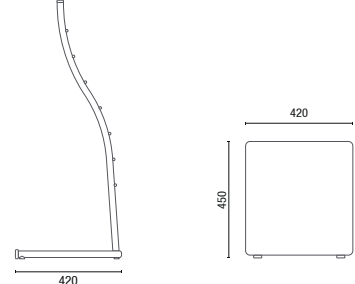

36030 Puff

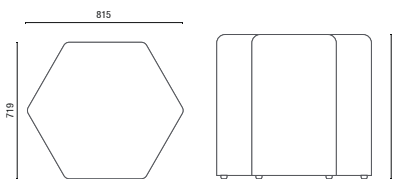

36675 Hexagonal Regular Alto 750mm

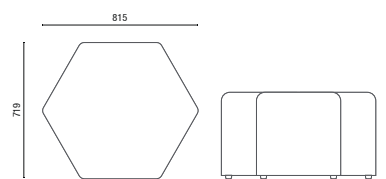

36645 Hexagonal Regular Médio 450mm

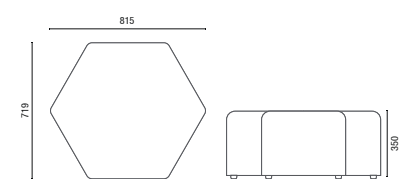

36635 Hexagonal Regular Baixo 350mm

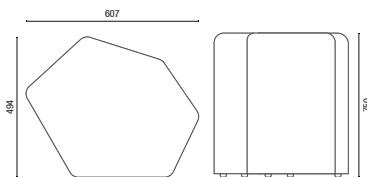

36475 Hexagonal Irregular Alto 750mm

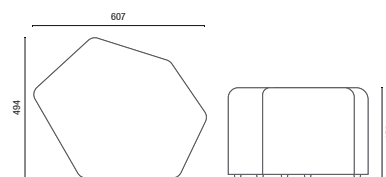

36445 Hexagonal Irregular Médio 450mm

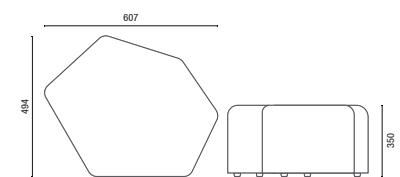

36350 Hexagonal Irregular Baixo 350mm

OBS: Medidas extremas obtidas sem o uso de gabarito de carga.



© Cavaletti S/A Cadeiras Profissionais
Rua Dr. Hiram Sampaio, 550
Erechim/RS Brasil 99.706-461
Fone/Fax: (54) 3520.4100
atendimento@cavaletti.com.br
www.cavaletti.com.br



Cavaletti

CADEIRAS PROFISSIONAIS

Cavaletti Spin

Cavaletti Spin

O sistema de sofás Spin proporciona configurações flexíveis para os mais diferentes arranjos de espaços colaborativos. São módulos lineares, curvos, pufes e acessórios que tornam os ambientes coletivos mais produtivos e versáteis.



Layout Lounge



Layout Espera



Layout Reunião



Layout Hub



CARACTERÍSTICAS



ERGONOMIA
 Ângulos e nível de amortecimento projetados para estimular a produtividade.

CONECTIVIDADE
 Opção de tomadas USB embutidas e integradas ao desenho do produto.

COMPLEMENTOS
 Aparadores e banquetas exclusivos que ampliam as possibilidades de combinação.

Layout Fórum

OBS: Lousa, aparadores, floreiras e vasos apenas ilustrativos.

CONFIGURAÇÕES



36.812
Conjunto high-back 1200mm
 Conexão USB Opcional



36.813
Módulo Reto 1300mm
 Conexão USB Opcional



36.865
Módulo Reto 650mm
 Conexão USB Opcional



36.805
Módulo Mesa
 Tampo de Madeira
 Conexão USB Opcional



36.845 IN
Módulo Curvo Encosto Interno 45°



36.890 IN
Módulo Curvo Encosto Interno 90°
 Conexão USB Opcional



36.818
Módulo Ponta Encosto Interno 180°
 Conexão USB Opcional



36.845 EX
Módulo Curvo Encosto Externo 45°



36.890 EX
Módulo Curvo Encosto Externo 90°
 Conexão USB Opcional



38030 PUFF
Puff Redondo com alça em couro



38035 PUFF
Puff Redondo Ginga



36.814
Banqueta Spin 705mm



36.802
Banqueta Spin 455mm



36.801
Aparador Spin



36.803
Mesa Spin



36.805 REDONDA
Mesa Redonda 1200mm



36.805 QUADRADA
Mesa Quadrada 750 x 750mm



11.801 4L
Mesa Retangular
 Conexão USB/Elétrica Opcional

DESENHOS TÉCNICOS

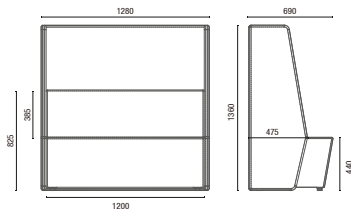

36.812
Conjunto high-back 1200mm

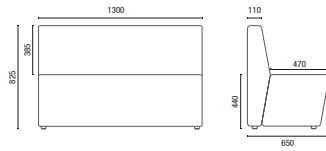

36.813
Módulo Reto 1300mm

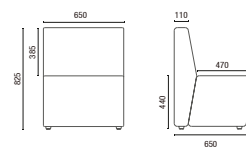

36.865
Módulo Reto 650mm

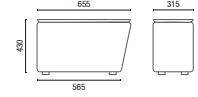

36.805
Módulo Mesa

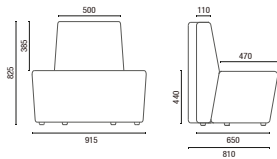

36.845 IN
Módulo Curvo Encosto Interno 45°

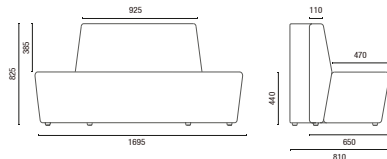

36.890 IN
Módulo Curvo Encosto Interno 90°

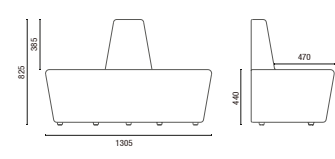

36.818
Módulo Ponta Encosto Interno 180°

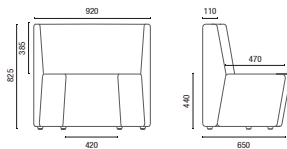

36.845 EX
Módulo Curvo Encosto Externo 45°

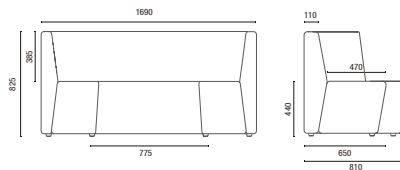

36.890 EX
Módulo Curvo Encosto Externo 90°

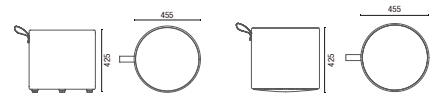

38030 PUFF
Puff Redondo
com alça em couro

38035 PUFF
Puff Redondo Ginga

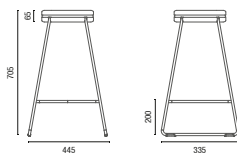

36.814 Banqueta Spin 705mm

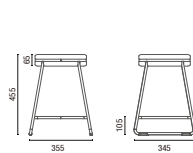

36.802 Banqueta Spin 455mm

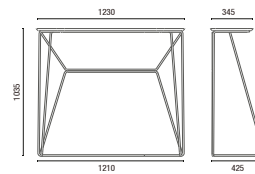

36.801 Aparador Spin

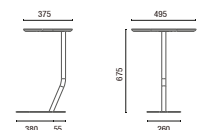

36.803 Mesa Spin

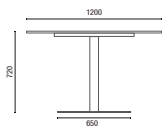

36.805 REDONDA
Mesa Redonda 1200mm

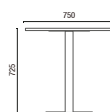

36.805 QUADRADA
Mesa Quadrada 750 x 750mm

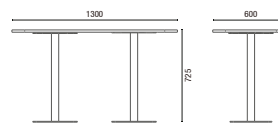

11.801 4L Mesa Retangular

OBS: Medidas extremas obtidas sem o uso de gabarito de carga.



Cavaletti S/A Cadeiras Profissionais
Rua Dr. Hiram Sampaio, 550
Erechim/RS Brasil 99.706-461
Fone/Fax: (54) 3520.4100
atendimento@cavaletti.com.br
www.cavaletti.com.br



Cavaletti[®]

CADEIRAS PROFISSIONAIS



Cavaletti Talk

Cavaletti Talk

Colaboração é a tendência contemporânea no mundo do trabalho. A linha Cavaletti Talk foi projetada para aumentar a produtividade, estimulando reuniões e conversas rápidas e informais. Além das versões básicas sem encosto ou com encosto baixo, conheça a opção high-back (encosto alto), que cria um ponto de reunião dentro do escritório ou lounge, otimizando a instalação, gerando economia de espaço (diagrama ao lado) e facilitando mudanças futuras de layout.

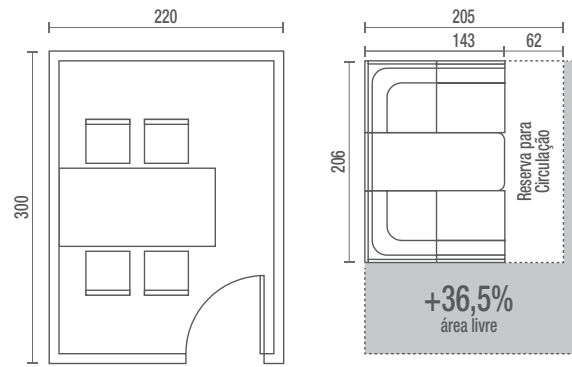

Sala de Reunião Tradicional
6,60 m²

Ponto de Reunião Talk
3m² + 1,25m² (área de circulação)



CONFIGURAÇÕES



36.505
Poltrona
Braço Duplo e Encosto



36.505
Sofá Canto
Braço e Encosto



36.505
Sofá Central
Encosto



36.505
Banco



36.555
HB Duplo



36.575
HB Face-to-Face
Mesa Interna
Box Eletrificado (Opcional)



36.565
HB Reunião
Mesa Interna
Box Eletrificado (Opcional)



11.801
Mesa Talk

DESENHOS TÉCNICOS

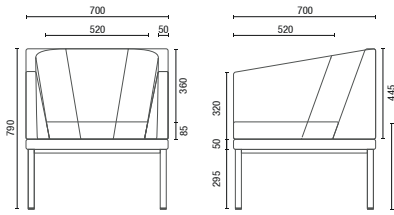

36.505 Poltrona

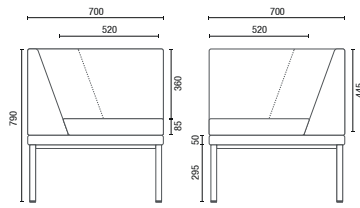

36.505 Sofá Canto

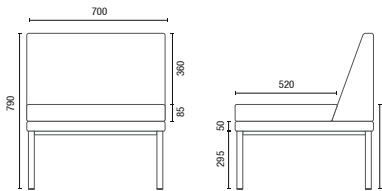

36.505 Sofá Central

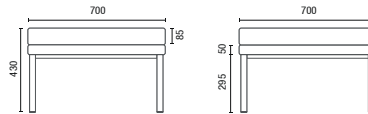

36.505 Banco

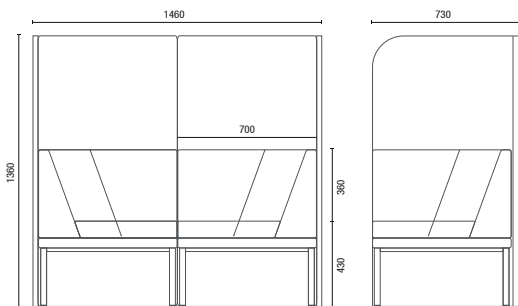

36.555 HB Duplo

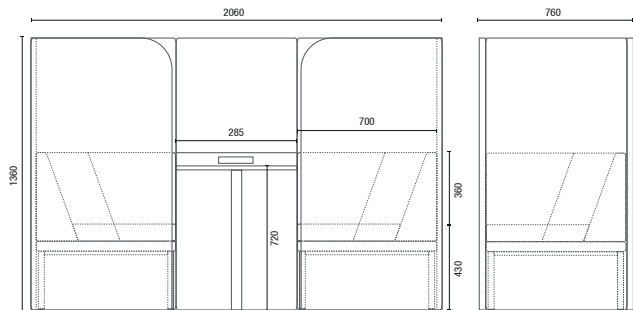

36.575 HB Face-to-Face

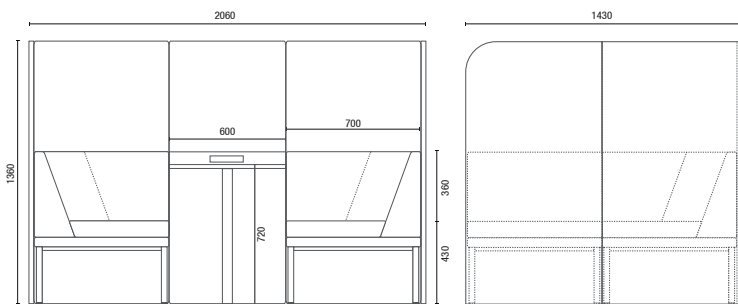

36.565 HB Reunião

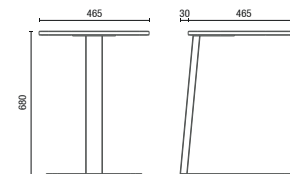

11.801 Mesa Talk

OBS: Medidas extremas obtidas sem o uso de gabarito de carga.

Cavaletti
CADEIRAS PROFISSIONAIS

Cavaletti S/A Cadeiras Profissionais
Rua Dr. Hiram Sampaio, 550
Erechim/RS Brasil 99.706-461
Fone/Fax: (54) 3520.4100
atendimento@cavaletti.com.br
www.cavaletti.com.br



Cavaletti

CADEIRAS PROFISSIONAIS

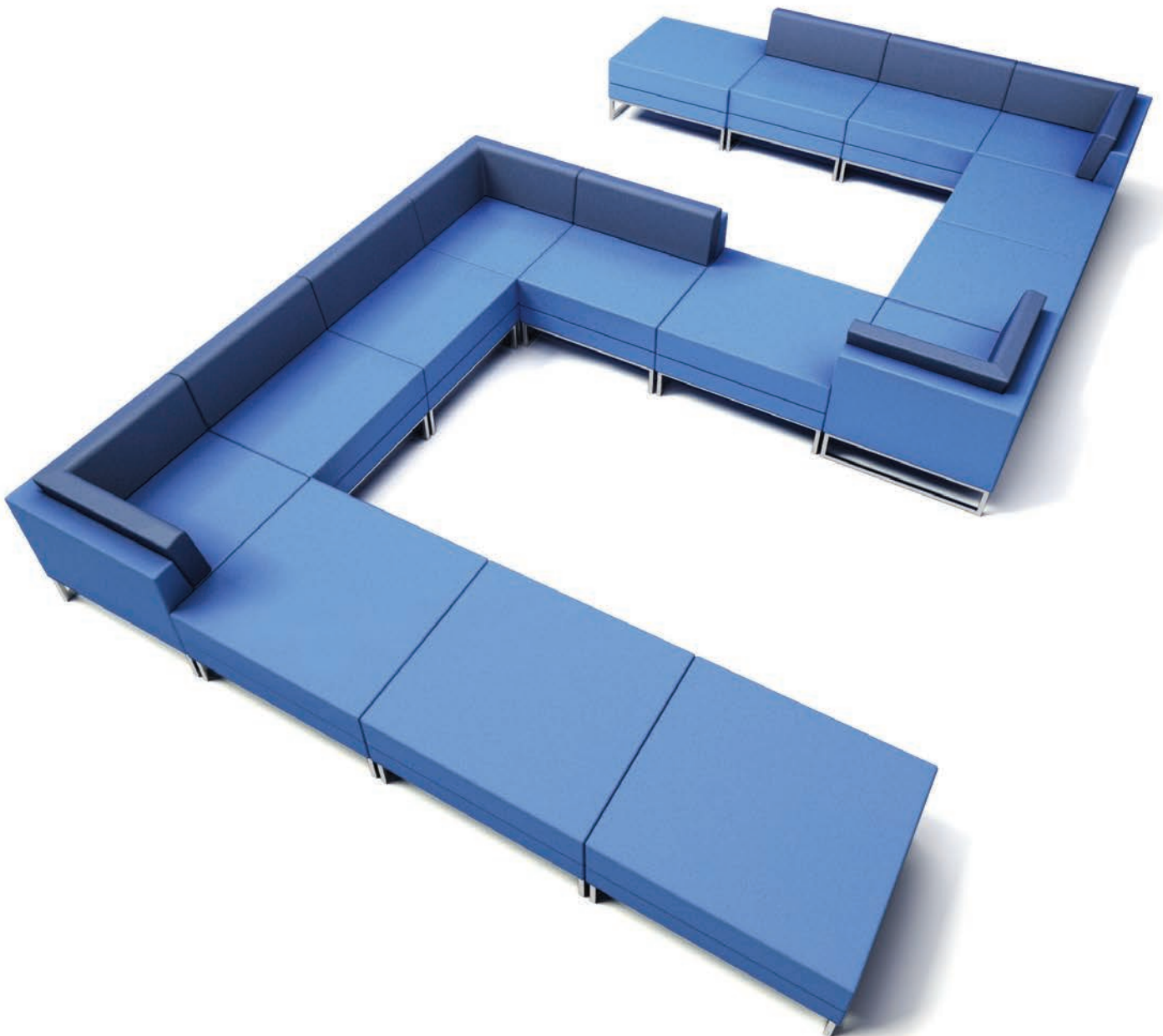

Cavaletti Connect

Cavaletti Connect

A linha de estofados Connect apresenta um design universal, com construção simples e prática, trazendo conforto de modo inteligente para espaços de lounge e estar em geral. Seus módulos permitem diferentes arranjos de montagem, oferecendo dinamismo e beleza aos ambientes.



CONFIGURAÇÕES



36205
Poltrona
Braço Duplo e Encosto



36205
Sofá Canto
Braço e Encosto



36205
Sofá Central
Encosto



36205
Banco

DESENHOS TÉCNICOS

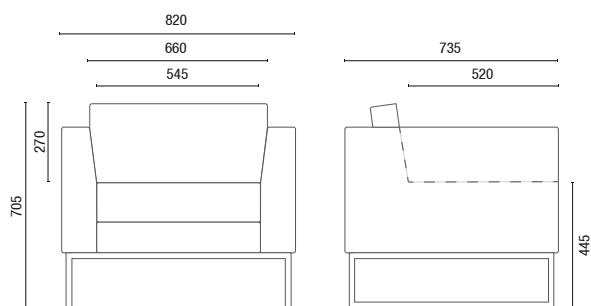

36205 Poltrona

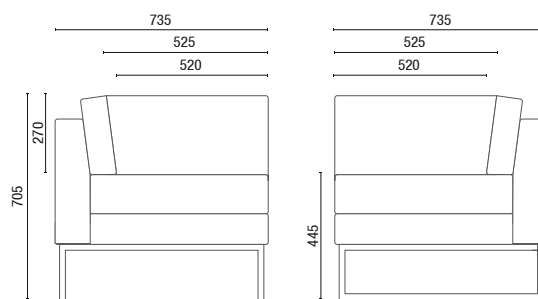

36205 Sofá Canto

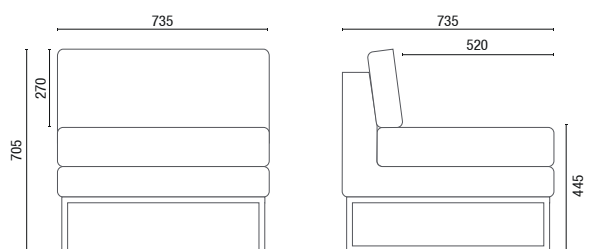

36205 Sofá Central

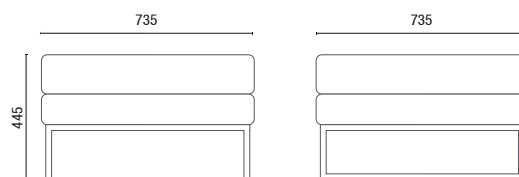

36205 Banco

OBS: Medidas extremas obtidas sem o uso de gabarito de carga.



Cavaletti S/A Cadeiras Profissionais
 Rua Dr. Hiram Sampaio, 550
 Erechim/RS Brasil 99.706-461
 Fone/Fax: (54) 3520.4100
 atendimento@cavaletti.com.br
 www.cavaletti.com.br



Cavaletti

CADEIRAS PROFISSIONAIS



Cavaletti Spot

Cavaletti Spot

Direcionada a áreas de espera, lounges e espaços coletivos, os modelos da linha Spot destacam-se pela singularidade do desenho, podendo ser utilizados tanto em ambientes comerciais quanto residenciais.



36060
Poltrona Espera
Giratória
Base Alumínio 4 Hastes
Concha em Madeira
com Estofamento

CONFIGURAÇÕES



36010
Poltrona Espera
Giratória
Base Alumínio Disco



36010
Poltrona Espera
Fixa ou Giratória
Base 4 Pés



36040
Poltrona Espera
Estrutura Arco



36050
Poltrona Espera
Fixa ou Giratória



36060
Poltrona Espera
Giratória
Base Alumínio 4 Hastes
Concha Estofada

ESTRUTURAS

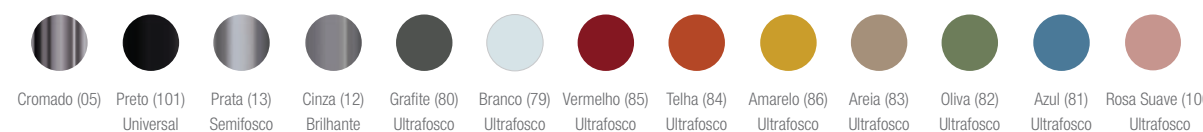

REVESTIMENTOS
Diversas opções de revestimentos:
CEC - Stilo, Couro Natural, Grid,
Haven, Liv, Mescla, Poliéster,
Politex, Space e Vinil.



BASES E ESTRUTURAS
Opções de base Fixa ou Giratória conforme o modelo.
Acabamento Cromado (bases em Aço), Polido (bases em
Alumínio) ou Pintura Epoxi (com 12 opções de cores).

DESENHOS TÉCNICOS

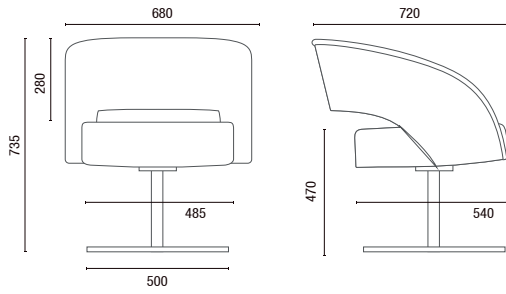

36010 Poltrona Espera Base Disco

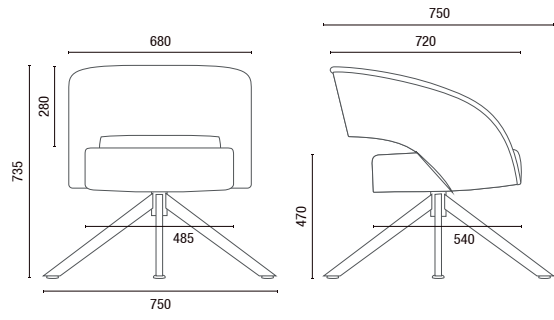

36010 Poltrona Espera Base 4 Pés

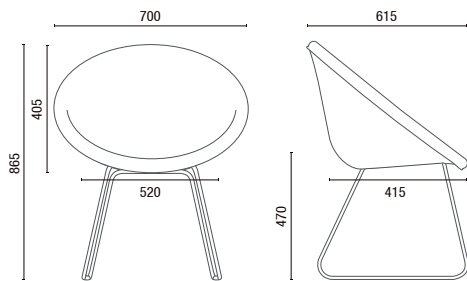

36040 Poltrona Espera

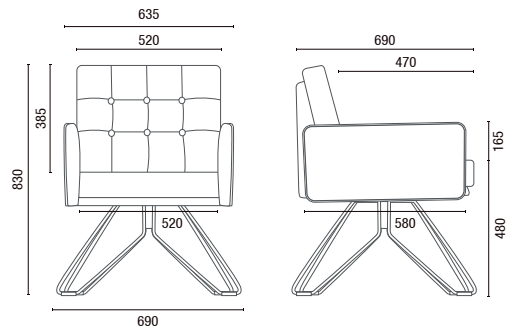

36050 Poltrona Espera

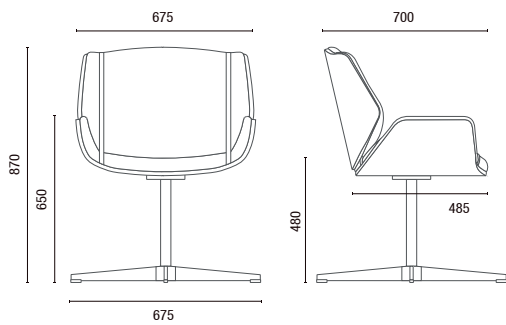

36060 Poltrona Espera

OBS: Medidas extremas obtidas sem o uso de gabarito de carga.



Cavaletti S/A Cadeiras Profissionais
Rua Dr. Hiram Sampaio, 550
Erechim/RS Brasil 99.706-461
Fone/Fax: (54) 3520.4100
atendimento@cavaletti.com.br
www.cavaletti.com.br



Cavaletti®

CADEIRAS PROFISSIONAIS



Cavaletti Box

Cavaletti Box

Criada para ambientes de recepção e espera, a linha Box proporciona conforto na medida ideal. Os estofados são facilmente combináveis e suas dimensões compactas otimizam o aproveitamento do espaço.



36020
Poltrona Espera
Fixa ou Giratória
Base 4 Pés

CONFIGURAÇÕES



36105
Sofá Espera
1 Lugar



36105
Sofá Espera
2 Lugares



36105
Sofá Espera
3 Lugares



12004
Sofá Espera
1 Lugar



12004
Sofá Espera
2 Lugares



12004
Sofá Espera
3 Lugares



12205
Sofá Espera
1 Lugar



12205
Sofá Espera
2 Lugares



12205
Sofá Espera
3 Lugares



12105
Sofá Espera
1 Lugar



12105
Sofá Espera
2 Lugares



12105
Sofá Espera
3 Lugares

DESENHOS TÉCNICOS

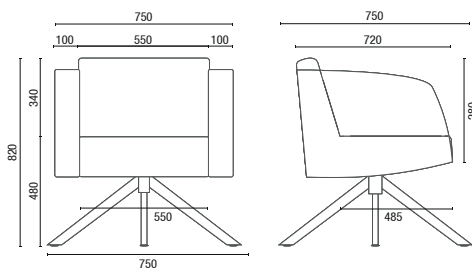

36020 Sofá Espera

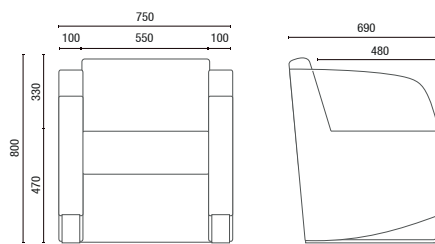

36105 Sofá Espera

Larguras:
1L – 750mm
2L – 1280mm
3L – 1820mm

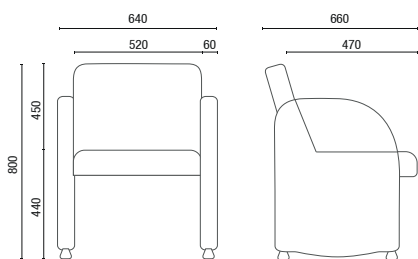

12004 Sofá Espera

Larguras:
1L – 640mm
2L – 1170mm
3L – 1700mm

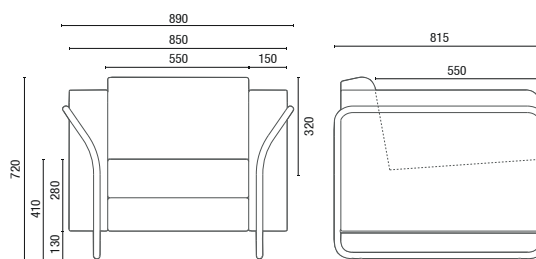

12205 Sofá Espera

Larguras:
1L – 890mm
2L – 1350mm
3L – 1850mm

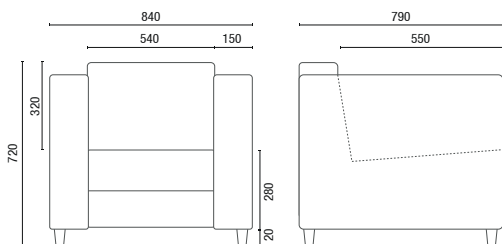

12105 Sofá Espera

Larguras:
1L – 840mm
2L – 1300mm
3L – 1800mm

OBS: Medidas extremas obtidas sem o uso de gabarito de carga.



Cavaletti S/A Cadeiras Profissionais
Rua Dr. Hiram Sampaio, 550
Erechim/RS Brasil 99.706-461
Fone/Fax: (54) 3520.4100
atendimento@cavaletti.com.br
www.cavaletti.com.br





Cavaletti

CADEIRAS PROFISSIONAIS

Cavaletti Coletiva



Cavaletti Coletiva

Projetada para atender uma grande variedade de arquiteturas e tipos de evento, a linha Coletiva se destaca pela construção sólida que objetiva maior durabilidade. Com opções de acabamentos e acessórios, os produtos da Coletiva garantem ótimos níveis de usabilidade ao longo de toda sua vida útil.



12020
Braços Intercalados

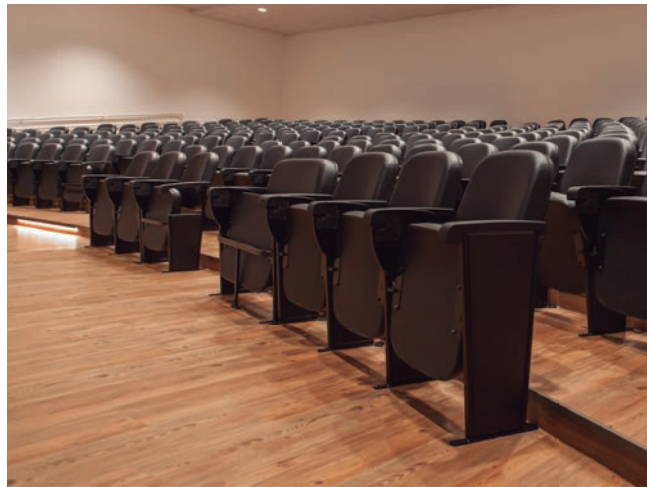

12011
Braços Intercalados

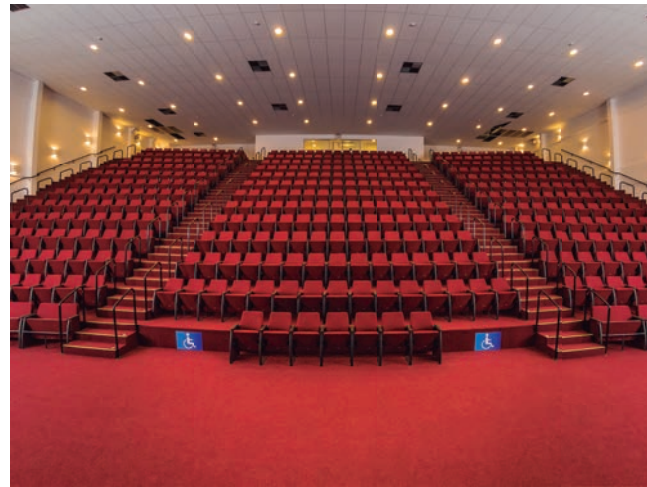

12020
Braços Intercalados



12018
Braços Intercalados

CONFIGURAÇÕES



12030
Auditório



12020
Auditório



12018
Auditório



12011
Auditório



1001
Empilhável



1002
Empilhável



1003
Empilhável



35013
Empilhável



1100
Carro para Transporte

CONFIGURAÇÕES

	Braços Intercalados	Braços Duplos	P.M.R. (Pessoa com Mobilidade Reduzida)	P.O. (Pessoa Obeso)	Extra	Prancheta Escamoteável	Prancheta Removível	Prancheta Fixa	Empilhamento Máximo	Carro para Transporte (1100)
12030	●	●	●	●		●				
12020	●	●	●	●		●				
12018	●	●	●	●		●				
12011	●	●	●	●		●				
1001					*●	*●	*●	*●	10	●
1002					*●	*●	*●	*●	10	●
1003						●			05	●
35013						●	●		02	

POLTRONAS

* Todas pranchetas removíveis para o empilhamento.

DESENHOS TÉCNICOS

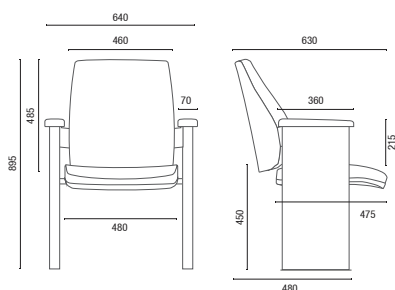

12030 Auditorio

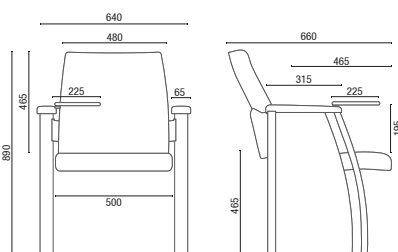

12020 UE Auditorio com Prancheta

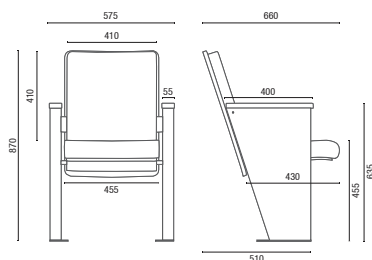

12018 Auditorio

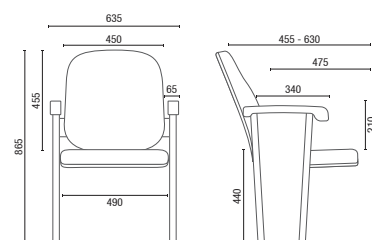

12011 Auditorio

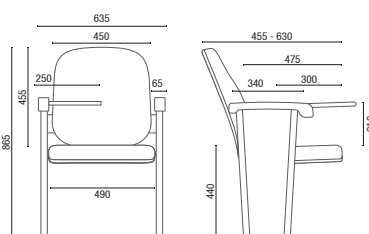

12011 UE Auditorio com Prancheta

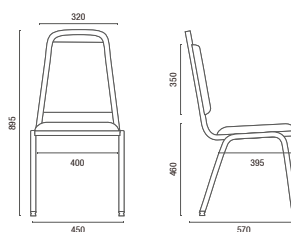

1001 Empilhavel

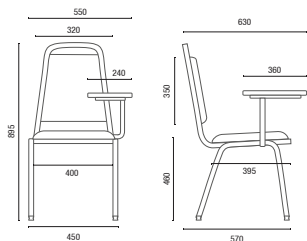

1001 U Empilhavel com Prancheta

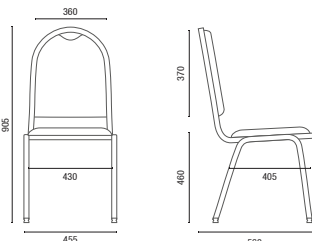

1002 Empilhavel

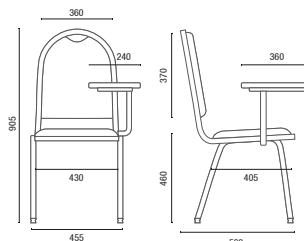

1002 U Empilhavel com Prancheta

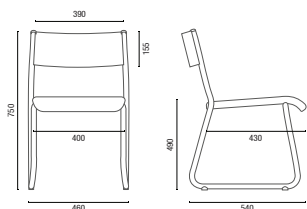

1003 Empilhavel

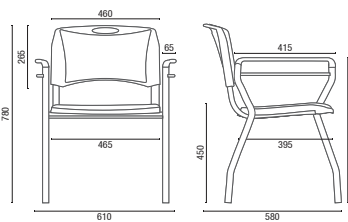

35013 Empilhavel

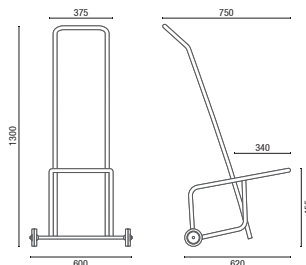

1100 Carrinho para Transporte



Cavaletti S/A Cadeiras Profissionais
 Rua Dr. Hiram Sampaio, 550
 Erechim/RS Brasil 99.706-461
 Fone/Fax: (54) 3520.4100
 atendimento@cavaletti.com.br
 www.cavaletti.com.br





Cavaletti

CADEIRAS PROFISSIONAIS

Cavaletti Match



Cavaletti Match

Na medida em que os ambientes se adaptam à flexibilização dos estilos de trabalho, a linha Match proporciona liberdade de utilização, incorporando ampla diversidade de combinações – do tradicional ao contemporâneo.

Despojada, versátil e plural.

Com bases metálicas ou em madeira, 14 cores de plásticos, 11 cores de pintura e mais de 90 opções de revestimentos disponíveis, a linha Match permite compor o produto à sua maneira.



Um convite à simplicidade e ao conforto.

O desenho ergonômico da concha da linha Match oferece 4 opções de configuração: é possível tanto optar pela concha totalmente injetada em peça única quanto complementá-la com o exclusivo sobre-assento para um desenho mais distintivo.

*Sobre-assento disponível somente na cor Grafite (45).



1. Concha Plástica
2. Concha Plástica + Sobre-Assento Plástico
3. Concha Plástica + Sobre-Assento Estofado
4. Concha Estofada + Sobre-Assento Estofado

Desenhada para combinar.

Para atender as diversas necessidades seja em ambientes privados, de espera, ou compartilhados, a linha Match oferece praticidade e múltiplos níveis de conforto para focar ou interagir.



A versão totalmente revestida e com base colorida oferece a combinação ideal entre conforto e design.

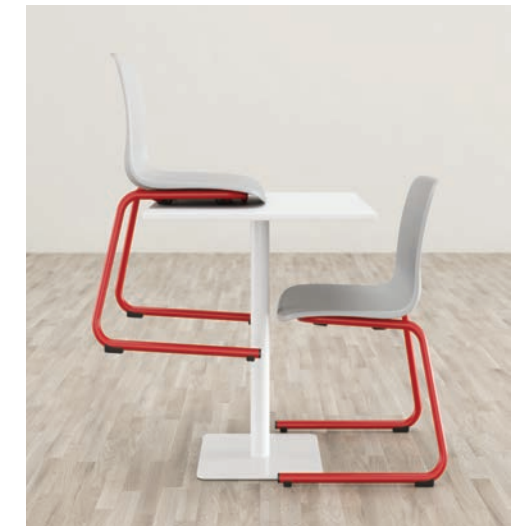





















A versão com estrutura C facilita a manutenção de espaços coletivos como salas de aula e refeitórios.



São três opções de estruturas em madeira, caracterizando peças atemporais e elegantes.

CONFIGURAÇÕES

	1. Concha Plástica	2. Concha Plástica + Sobre-Assento Plástico	3. Concha Plástica + Sobre-Assento Estofado	4. Concha Estofada + Sobre-Assento Estofado
Cadeira fixa palito	 46.006	 46.056	 46.066	 46.076
Cadeira fixa palito, com braço	 46.906	 46.956	 46.966	 46.976
Cadeira fixa arco	 46.007	 46.057	 46.067	 46.077
Cadeira fixa arco, com braço	 46.907	 46.957	 46.967	 46.977
Cadeira fixa C	 46.005	 46.055	 46.065	 46.075
Cadeira fixa pé palito com braço, madeira envernizada	 46.406	 46.456	 46.466	 46.476
Cadeira fixa pé piramidal, madeira envernizada	 46.206	 46.256	 46.266	 46.276

	1. Concha Plástica	2. Concha Plástica + Sobre-Assento Plástico	3. Concha Plástica + Sobre-Assento Estofado	4. Concha Estofada + Sobre-Assento estofado
Cadeira fixa pé palito, madeira envernizada	 46.306	 46.356	 46.366	 46.376
Cadeira giratória	 46.003	 46.053	 46.063	 46.073
Cadeira giratória, com braço	 46.903	 46.953	 46.963	 46.973
Banqueta base disco	 46.022	 46.052	 46.062	 46.072
Banqueta palito	 46.020	 46.050	 46.060	 46.070
Cadeira giratória, com prancheta 360° e porta livro.	 46.103	 46.153	 46.163	 46.173
Cadeira palito com rodízio, porta livro e prancheta	 46.106	 46.156	 46.166	 46.176

REVESTIMENTOS



Poliéster
27 cores

Politex
06 cores

Liv
14 cores



Haven
15 cores

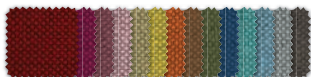

Grid
14 cores



CEC
10 cores



Vinil
11 cores

ACABAMENTOS

Cores Plásticas

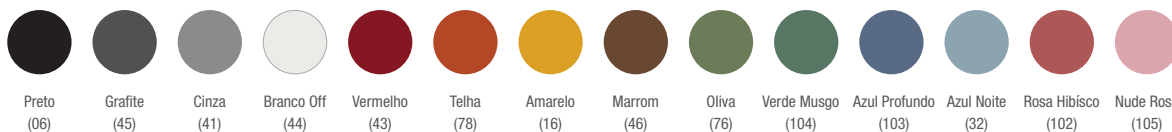

Preto (06) Grafite (45) Cinza (41) Branco Off (44) Vermelho (43) Telha (78) Amarelo (16) Marrom (46) Oliva (76) Verde Musgo (104) Azul Profundo (103) Azul Noite (32) Rosa Hibisco (102) Nude Rosé (105)

*Sobre-assento e apoia braços disponíveis somente na cor Grafite (45).

Cores de Bases

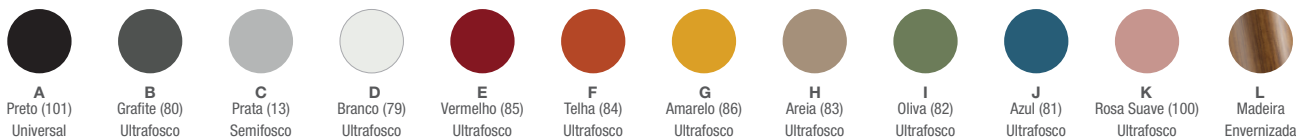

A Preto (101) Universal **B** Grafite (80) Ultrafosco **C** Prata (13) Semifosco **D** Branco (79) Ultrafosco **E** Vermelho (85) Ultrafosco **F** Telha (84) Ultrafosco **G** Amarelo (86) Ultrafosco **H** Areia (83) Ultrafosco **I** Oliva (82) Ultrafosco **J** Azul (81) Ultrafosco **K** Rosa Suave (100) Ultrafosco **L** Madeira Envernizada

Melâmnicos - Pranchetas e Porta livros

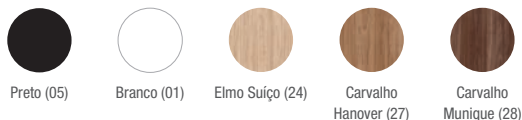

Preto (05) Branco (01) Elmo Suíço (24) Carvalho Hanover (27) Carvalho Munique (28)

DESENHOS TÉCNICOS

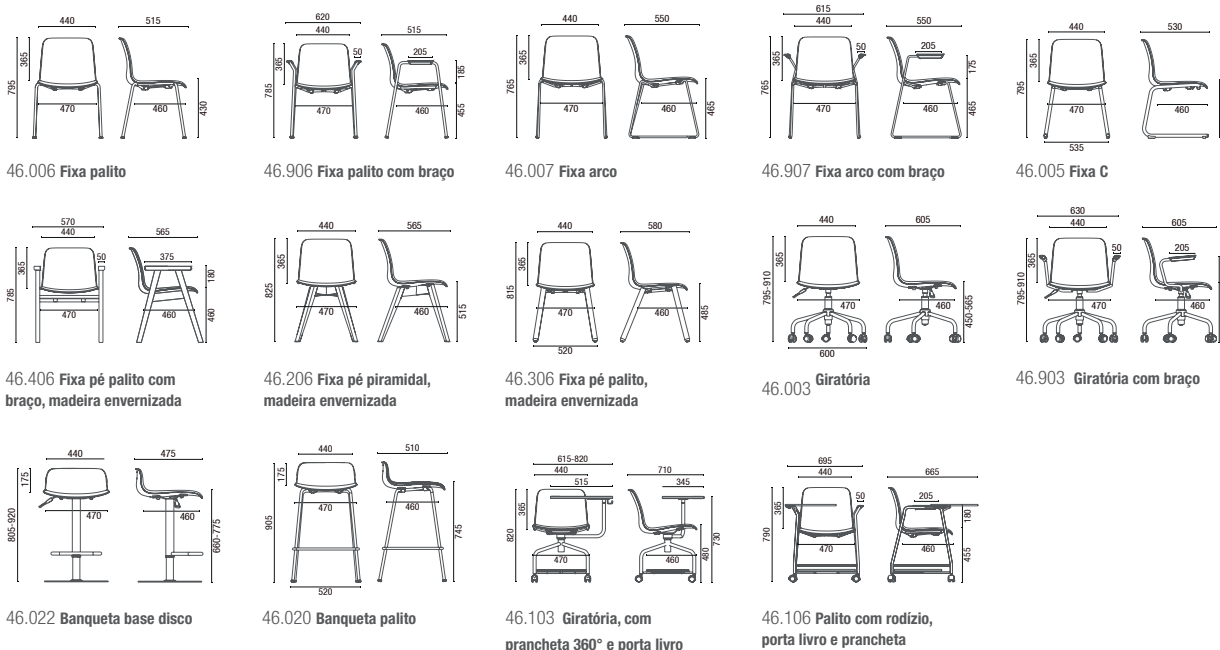

OBS: Medidas extremas obtidas sem o uso de gabarito de carga. Para especificação de cores e acabamentos, utilizar sempre amostras físicas originais Cavaletti.



Cavaletti S/A Cadeiras Profissionais
Rua Dr. Hiram Sampaio, 550
Erechim/RS Brasil 99.706-461
Fone/Fax: (54) 3520.4100
atendimento@cavaletti.com.br
www.cavaletti.com.br



Cavaletti

CADEIRAS PROFISSIONAIS



Cavaletti Yon



única, como você

Inspirada na individualidade, a Cavaletti Yon é um produto com características que atendem as necessidades sensoriais de cada pessoa, seja no home ou no office. Reflete preferências, expressando as diferenças existentes.

Cavaletti **YON**

**CONNECTADA
AO SEU ESTILO**

YON

Apoio de Cabeça

Apoio de cabeça com altura regulável, em polipropileno copolímero, injetado nas cores Azul Profundo, Vermelho Aurora, Cinza e Preto. Estofado com espuma de Alta Performance e revestido nos acabamentos e cores disponíveis para a linha.

Encosto

Encosto com regulagem de altura, injetado em poliamida, nas cores Azul Profundo, Vermelho Aurora, Cinza e Preto.

Apoio Lombar

Apoio lombar com ajuste de altura, injetado em poliamida, nas cores Azul Profundo, Vermelho Aurora, Cinza e Preto.

Mecanismo

Mecanismo Sincron de 4 estágios com regulagem de tensão por manípulo frontal ou Mecanismo SRY, com inclinação do encosto em diversas posições.

Bases

Opções de Bases em Aço com Capa ou Estampada, com rodízios de 50mm em Nylon ou PU, disponíveis nas cores preto ou cinza, Bases em Alumínio ou Nylon, com rodízios de 65mm em Nylon ou PU, disponíveis na cor preto e Bases Up com rodízios de 65mm em Nylon ou PU, disponíveis nas cores Azul Profundo e Vermelho Aurora. Estruturas fixas com sapatas, Braços Integrados (SI) e pintura nas cores Prata ou Preto Universal.

DO HOME AO OFFICE!



Azul Profundo

Braço

Braço regulável MC.

Base

Bases Up com Rodízios 65mm em Nylon ou PU.

Estrutura

Estrutura em polímero de engenharia disponível em Azul Profundo.

OBS: Produto nesta imagem com Tela Vêlo Grafite 308 e Grid Cinza Névoa 352.

Vermelho Aurora

Braço

Braço regulável MC.

Base

Bases Up com Rodízios 65mm em Nylon ou PU.

Estrutura

Estrutura em polímero de engenharia disponível em Vermelho Aurora.

OBS: Produto nesta imagem com Tela Vêlo Grafite 308 e Grid Cinza Névoa 352.



Cinza

Braço

Braços SL, SL New PP (todos com opção de Regulagem Lateral), MC e TC.

Base

Bases em Alumínio ou Nylon, com rodízios de 65mm em Nylon ou PU. Base Estampada ou Aço com Capa, somente rodízios de 50mm em Nylon ou PU.

Estrutura

Estrutura em polímero de engenharia disponível em Cinza.

OBS: Produto nesta imagem com Tela Flip Cinza 601 e Grid Cinza Névoa 352.

Preto

Braço

Braços SL, SL New PU, SL New PP (todos com opção de Regulagem Lateral), 3D, MC e TC.

Base

Bases em Alumínio ou Nylon, com rodízios de 65mm em Nylon ou PU. Base Estampada ou Aço com Capa, somente rodízios de 50mm em Nylon ou PU.

Estrutura

Estrutura em polímero de engenharia disponível em Preto.

OBS: Produto nesta imagem com Tela Flip Cinza 601 e Grid Cinza Névoa 352.



APLICAÇÕES TELAS

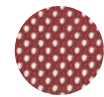

Vermelho 163

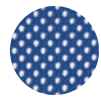

Azul 188

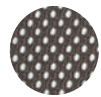

Marrom 187

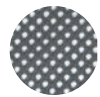

Cinza 165

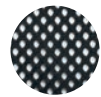

Preto 162



Preto 600

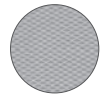

Cinza 601

NewNet - 47101 / 47106

05 cores

FLIP - 47201 / 47206

02 cores



Branco Metal 307

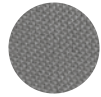

Grafite 308



Preto 300



Vermelho 309



Amarelo 305



Verde Lima 304



Marrom 306

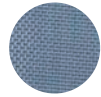

Azul 303

Vélo - 47301 / 47306

08 cores

CONFIGURAÇÕES

Confira abaixo algumas combinações possíveis para a Cavaletti Yon e escolha a sua.



47101 Tela NewNet
47201 Tela Flip
47301 Tela Vélo

Syncron
Braços MC
Base UP



47101 Tela NewNet
47201 Tela Flip
47301 Tela Vélo

Syncron
Braços MC
Base UP



47101 Tela NewNet
47201 Tela Flip
47301 Tela Vélo

Syncron
Braços SL
Base Nylon



47101 Tela NewNet + AC
47201 Tela Flip + AC
47301 Tela Vélo + AC

Syncron
Braço MC
Base Nylon



47101 Tela NewNet
47201 Tela Flip
47301 Tela Vélo

SRY
Braços SL New PP
Base Aço com Capa



47106 Tela NewNet
47206 Tela Flip
47306 Tela Vélo

Braços Integrados
Estrutura SI

OBS: Produto nesta imagem com Tela Vélo Grafite 308 e Grid Cinza Névoa 352; Tela Vélo Grafite 308 e Grid Cinza Névoa 352; Tela Vélo Grafite 308 e Grid Amarelo Siciliano 356; Tela Vélo Grafite 308 e Grid Amarelo Siciliano 356; NewNet Cinza 165 e Grid Amarelo Siciliano 356; Tela Vélo Grafite 308 e Grid Amarelo Siciliano 356.

REVESTIMENTOS

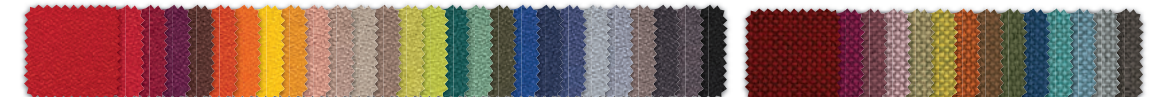

Poliéster

27 cores

Grid

14 cores

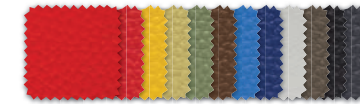

Vinil

12 cores

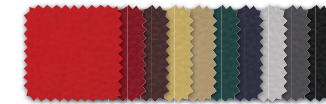

CEC - Stilo

10 cores

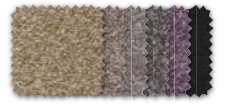

Politex

06 cores

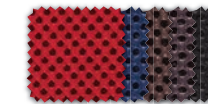

Space

05 cores

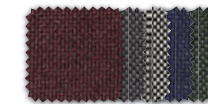

Mescla

05 cores

APOIO DE CABEÇA



Azul Profundo
CE4700003



Vermelho Aurora
CE4700004



Cinza
CE4700002



Preto
CE4700001



OBS: Produto nesta imagem com Tela Vélo Grafite 308 e Grid Cinza Névoa 352; Tela Flip Cinza 601 e Grid Azul Caribe 353; Tela Vélo Grafite 308 e Grid Cinza Névoa 352; Tela Flip Cinza 601 e Grid Rosa Camélia 351; Tela Vélo Grafite 308 e Grid Verde Floresta 357.

APRIMORE ESSA EXPERIÊNCIA!



Cavaletti

DESENHOS TÉCNICOS

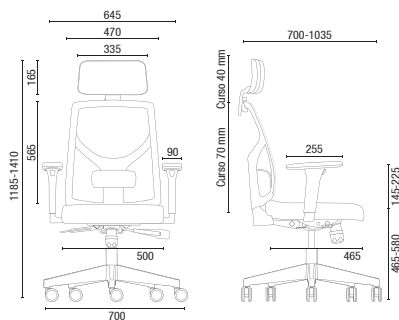

47101 Tela NewNet + AC
47201 Tela Flip + AC
47301 Tela Vélo + AC

Syncron
 Braço MC
 Base Nylon

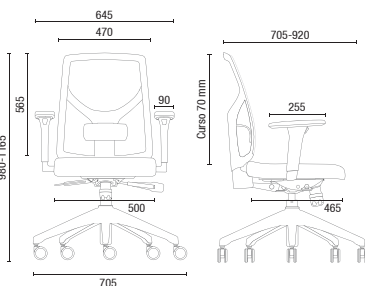

47101 Tela NewNet
47201 Tela Flip
47301 Tela Vélo

Syncron
 Braços MC
 Base UP

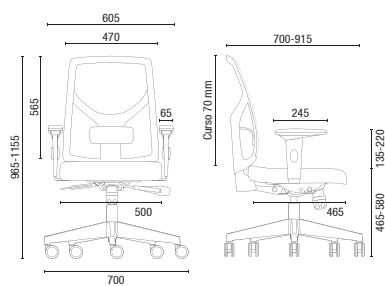

47101 Tela NewNet
47201 Tela Flip
47301 Tela Vélo

Syncron
 Braços SL
 Base Nylon

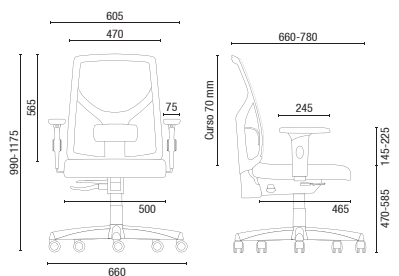

47101 Tela NewNet
47201 Tela Flip
47301 Tela Vélo

SRY
 Braços SL New PP
 Base Aço com Capa

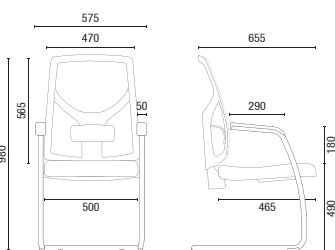

47106 Tela NewNet
47206 Tela Flip
47306 Tela Vélo

Braços Integrados
 Estrutura SI

OBS: Medidas extremas obtidas sem o uso de gabarito de carga.

OBS: Produto da capa com Tela Vélo Vermelho 309 e Grid Vermelho Persa 350.



Cavaletti S/A Cadeiras Profissionais
 Rua Dr. Hiram Sampaio, 550
 Erechim/RS Brasil 99.706-461
 Fone/Fax: (54) 3520.4100
 atendimento@cavaletti.com.br
 www.cavaletti.com.br



Procure por nossos produtos certificados FSC®



A marca do manejo florestal responsável



*Produtos Certificados na Norma ABNT NBR 13962, sob consulta ao Departamento Comercial - Setor Público.