

Cavaletti®

PROFESSIONAL SEATING



Cavaletti Coffee



Cavaletti Coffee

For meeting and social environments – from cafes, restaurants, waiting rooms to use as an approach chair – Cavaletti Coffee stands out for its quality of finish combined with its versatility of application.

CHARACTERISTICS

Shapes that invites

With smooth curves and simple shapes, Cavaletti Coffee's design composes shared environments in a practical and inviting way, especially when associated with the tables of the line.



Lightness and resistance

Attractively combined, the solid wood structure and the engineered polymer seat and back, bring lightness and resistance to Cavaletti Coffee. Also ensuring easy cleaning in high-turnover locations.



CONFIGURATIONS



25.006
Visitor
European Beech Wood Base



25.006
Visitor
European Beech Wood Base



25.101
Square Top Table
Melamine Top
Metal Base



25.102
Round Top Table
Melamine Top
Metal Base



39.801
Side Table
Melamine Top
Metal Base



39.802
Side Table
Melamine Top
Metal Base



39.803
Side Table
Melamine Top
Metal Base

DETAILS



Structure insolid wood
(European Beech)



Inviting shapes and
easy composition in
any space



Engineering polymer
contact surfaces



High strength with
load capacity of
up to 160kg

SURFACES

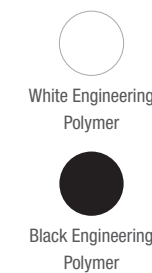

TABLE TOPS

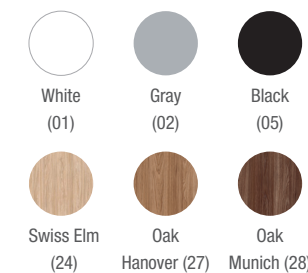
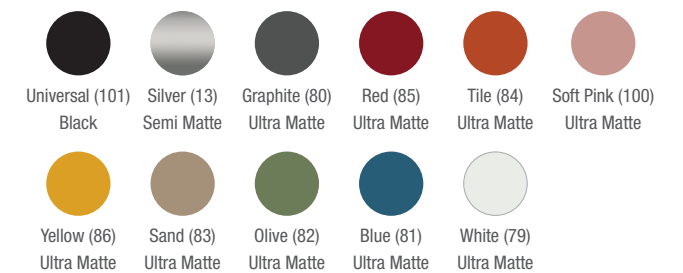
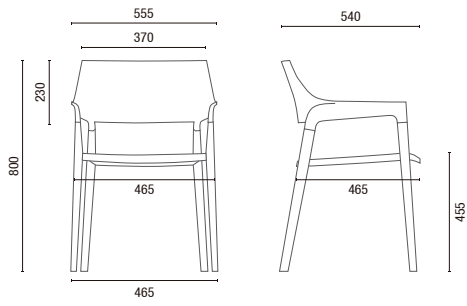

TABLE BASES



TECHNICAL DRAWINGS



25.006 **Visitor**

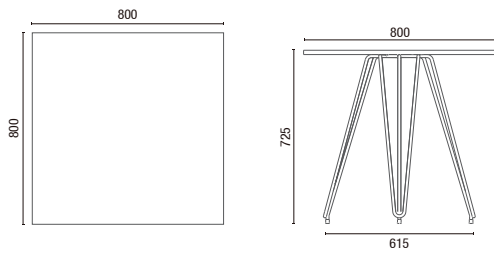

25.101 **Square Top Table**

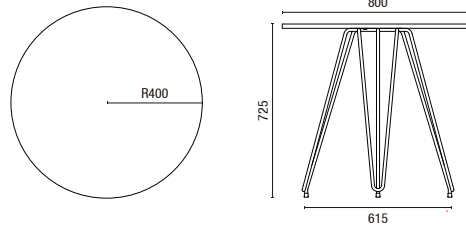

25.102 **Round Top Table**

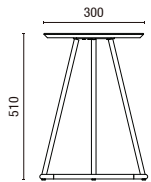

39.801 **Side Table**

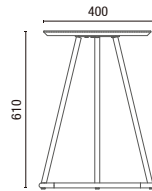

39.802 **Side Table**

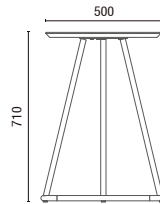

39.803 **Side Table**

NOTE: Extreme measurements obtained without using a load gauge. To specify colors and finishes, always use original physical samples from Cavaletti.



Cavaletti S/A Professional Seating
 Street Dr. Hiram Sampaio, 550
 Erechim/RS Brasil 99.706-461
 Fone/Fax: (54) 3520.4100
 atendimento@cavaletti.com.br
 www.cavaletti.com.br

